

PHILIPS

dynalite

DDMC802

Multipurpose
Modular Controller



Installation Instructions

Instructions d'installation
 Installationsanweisungen
 Instrucciones de instalación
 Istruzioni per l'installazione
 Installatie-instructies
 インストール手順
 安装指示
 إرشادات التركيب

⚡ Devices must be installed in an approved enclosure by a qualified electrician in accordance with all national and local electrical and construction codes and regulations.

Les appareils doivent être installés dans un lieu jugé apte, par un électricien qualifié et conformément aux règles et normes locales et nationales en matière d'électricité et de construction.

Die Geräte müssen von einem geprüften Elektriker entsprechend allen nationalen und lokalen Elektro- und Bauvorschriften in einem zugelassenen Gehäuse installiert werden.

Los dispositivos se deben instalar en un recinto aprobado por un electricista cualificado de acuerdo a todos los reglamentos eléctricos y de construcción locales y nacionales pertinentes.

I dispositivi devono essere installati da un elettricista qualificato in un luogo approvato, in conformità a tutti gli standard e le norme nazionali e locali vigenti in materia di impianti elettrici e costruzioni edilizie.

Apparaten moeten door een erkende elektricien worden geïnstalleerd in een goedgekeurde behuizing in overeenstemming met alle nationale en lokale elektriciteits- en bouwvoorschriften en wetgeving.

デバイスを取り付ける際は、資格のある電気技師に依頼し、電気と建設に関する国および地域のすべての法令に従って、認可されている筐体内に取り付けてください。

根据国家/地区及当地的电气与建筑规范和法规，该设备必须由有资质的电工安装在经批准的外罩内。

يلزم تركيب الأجهزة داخل حاوية معتمدة، من قبل كهربائي مؤهل وفقاً لجميع قوانين ولوائح الكهرباء والإنشاءات الوطنية والمحلية

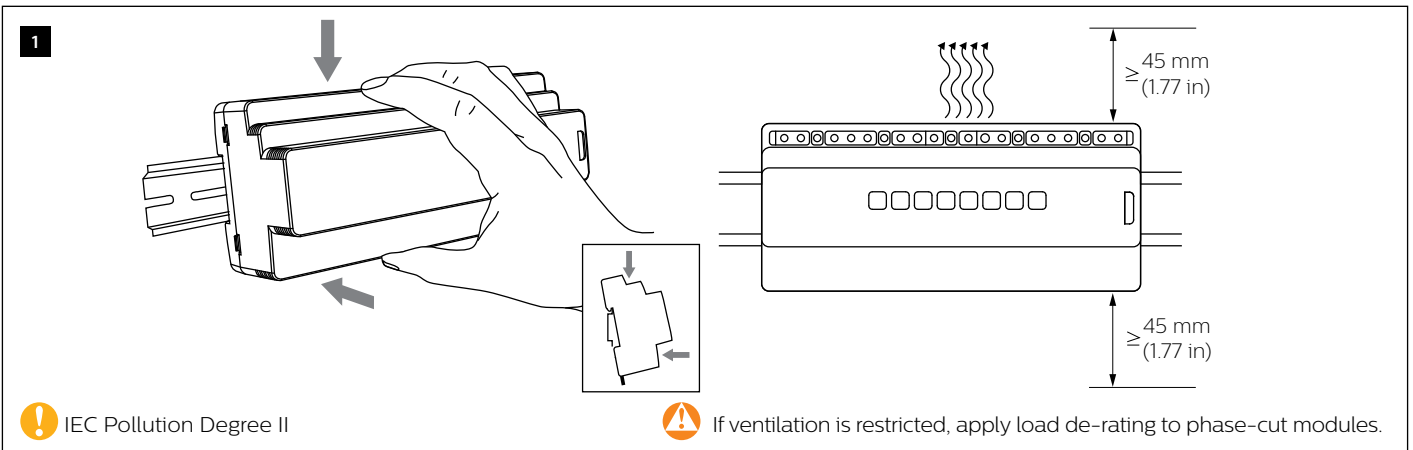
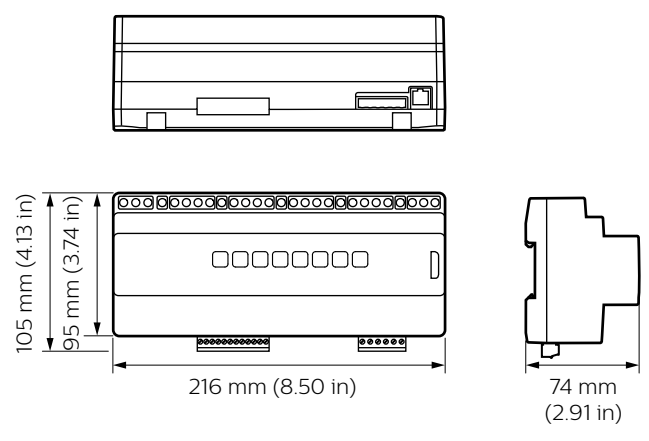
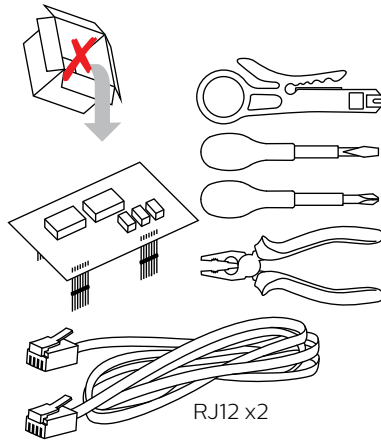
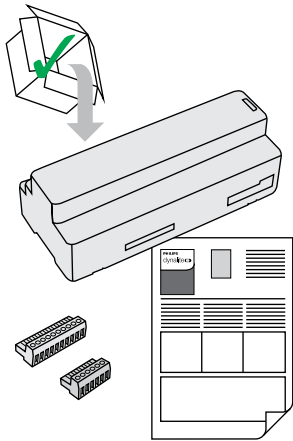

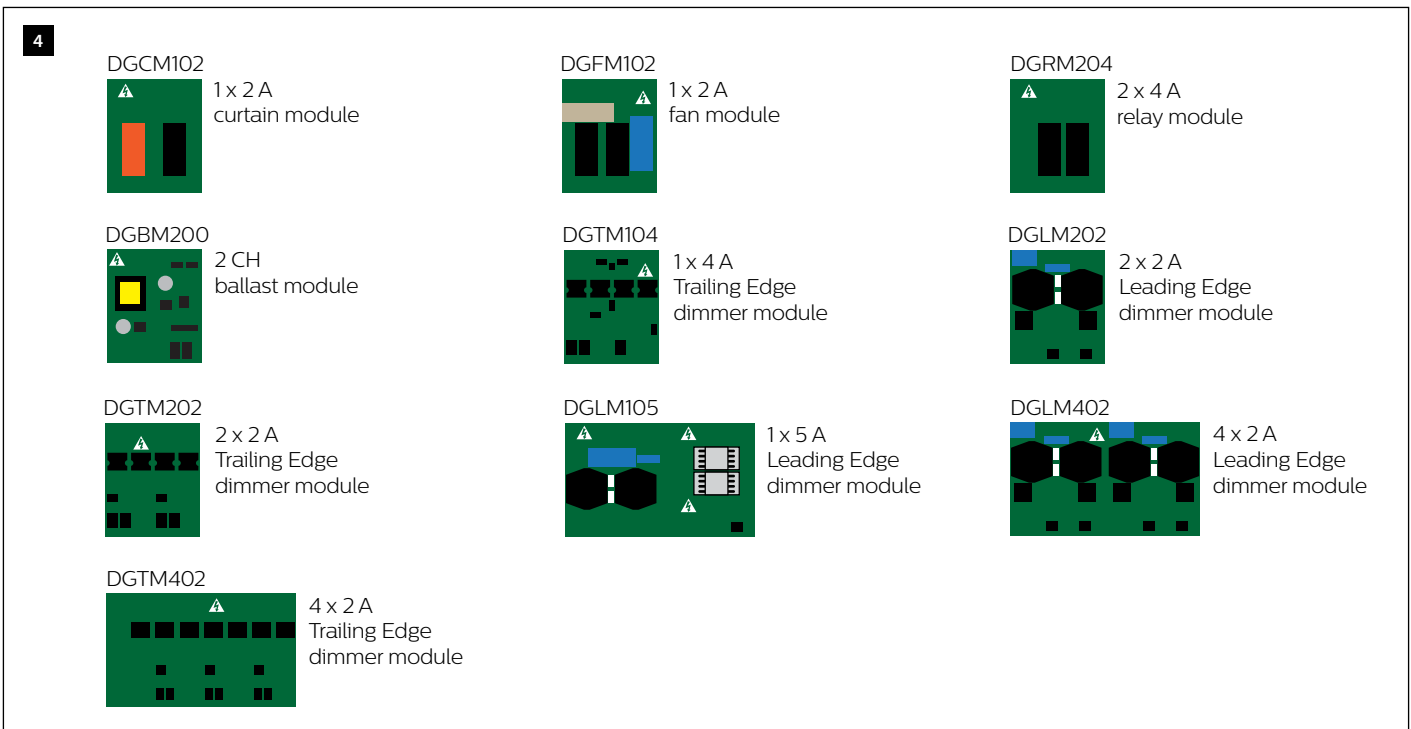
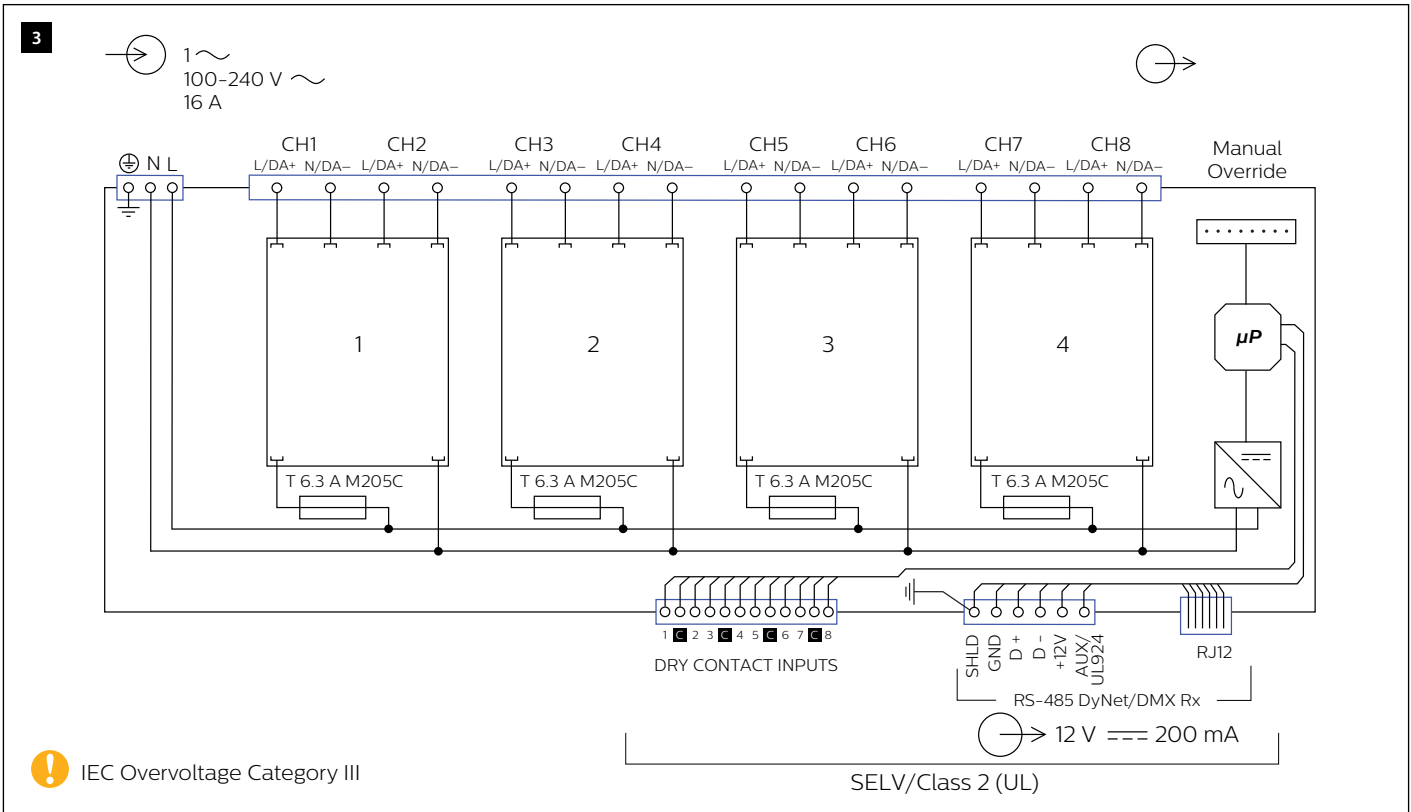
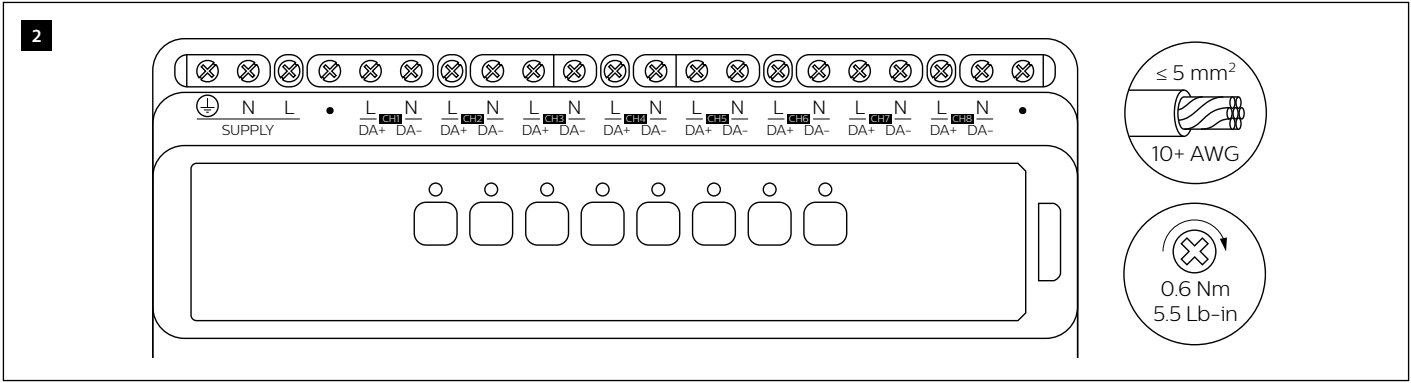

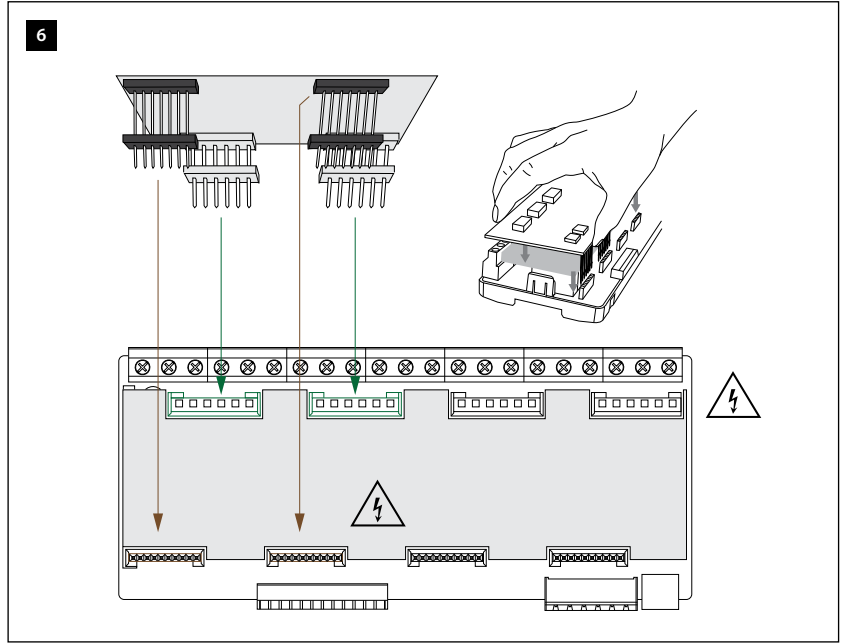
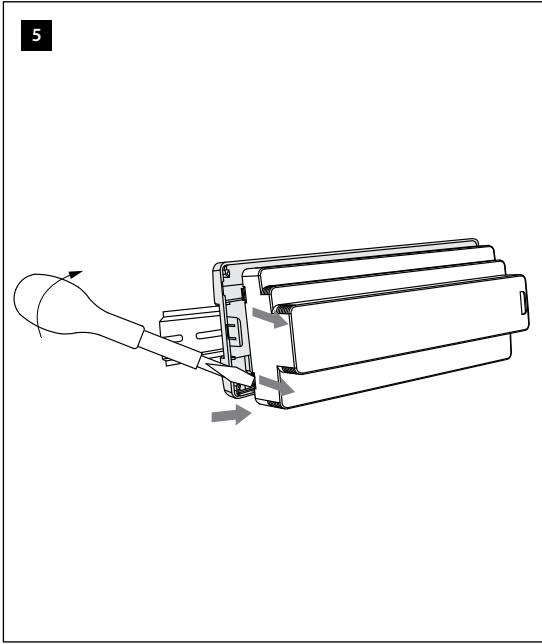

7 A

DGCM102
1 x 2 A
curtain module

Load Type	Output Ratings Per Channel
General use	2 A, 230 V ~
Motor x 1	4.4 FLA (1/6 HP), 120 V ~ 4.9 FLA (1/2 HP), 230 V ~

7 B

DGFM102
1 x 2 A
fan module

Load Type	Output Ratings Per Channel
Motor x 1	400 VA, 230 V ~

Not suitable for 120 V ~ (Not UL listed)

7 C

DGRM204
2 x 4 A
relay module

Load Type	Output Ratings Per Channel
General Use	4 A, 230 V ~
Incandescent	600 W, 120 V ~ 1100 W, 230 V ~
Magnetic with Halogen	2 A, 120 V ~
Electronic Driver	4 A, 120 V ~ 3 A, 230 V ~

Module Load ≤ 5 A

7 D

DGBM200
2 CH
ballast module

Protocol

A (CH1)
1-10 V DSI/DALI

B (CH2)
1-10 V DSI/DALI

Control Channel Ratings

DALI	≤ 5/CH Guaranteed 10 mA, Maximum 250 mA Insulation: basic	≤ 10
Broad-cast / DSI		
1-10 V	Sink 10 mA / Source 10 mA	

! Suitable for Class 1 or Class 2 wiring

7 E

DGTM104
1 x 4 A
TE dimmer module

Load Type	Output Ratings Per Channel
Incandescent	4 A, 120 (UL) / 230 V ~
Electronic Driver	4 A, 120 (UL) / 230 V ~

Not compatible with magnetic transformers.
Apply de-rating for electronic and LED loads.

7 F



DGLM202
2 x 2 A
LE dimmer module

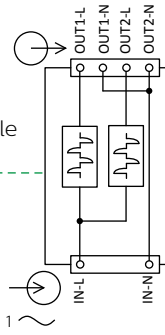

LoadType	Output Ratings Per Channel
Incandescent	2 A, 120 / 230 V ~
Magnetic with Halogen	2 A, 120 / 230 V ~
Electronic Driver*	2 A, 120 / 230 V ~

*can be limited by load capacitance.
Apply de-rating for electronic and LED loads.

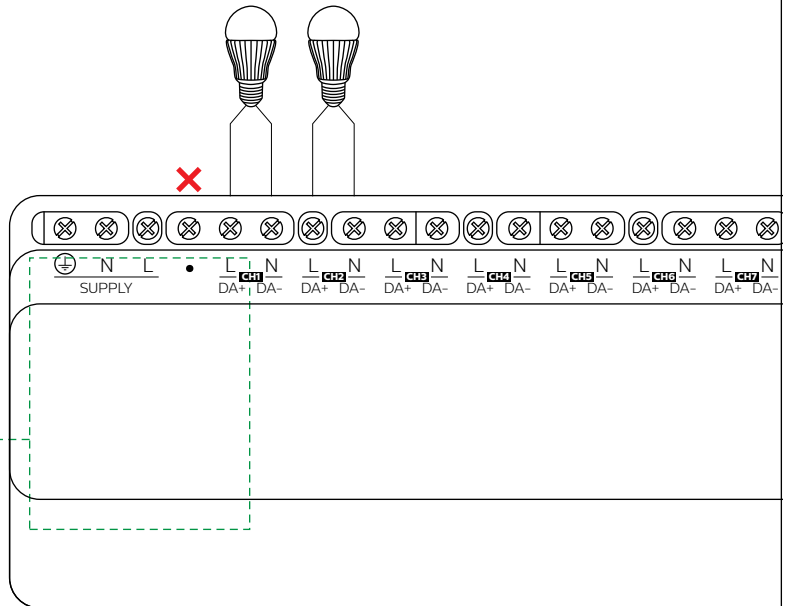

7 G



DGTM202
2 x 2 A
TE dimmer module

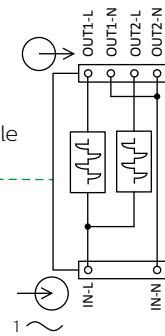

Load Type	Output Ratings Per Channel
Incandescent	2 A, 120 (UL) / 230 V ~
Electronic Driver	2 A, 120 (UL) / 230 V ~

Not compatible with magnetic transformers.
Apply de-rating for electronic and LED loads.

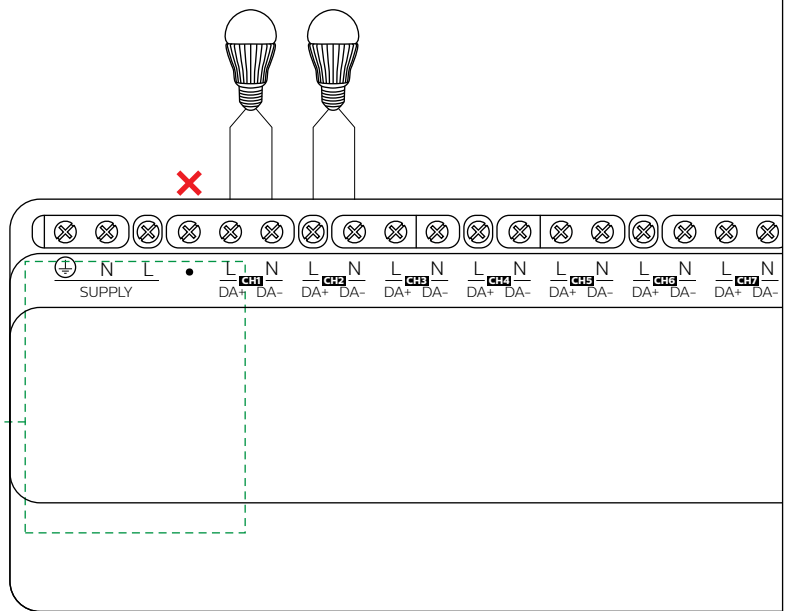

7 H



DGLM105
1 x 5 A
LE dimmer module

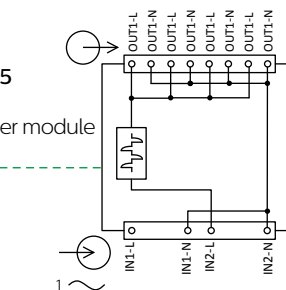

LoadType	Output Ratings Per Channel
Incandescent	5 A, 120 / 230 V ~
Magnetic with Halogen	5 A, 120 / 230 V ~
Electronic Driver*	5 A, 120 / 230 V ~

*can be limited by load capacitance
Apply de-rating for electronic and LED loads.

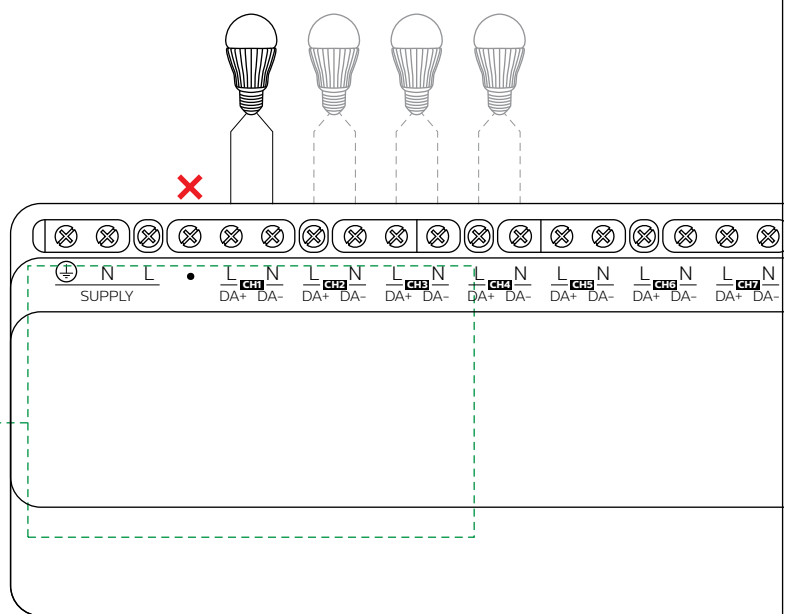

7 I

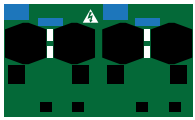

DGLM402
4 x 2 A
LE dimmer
module

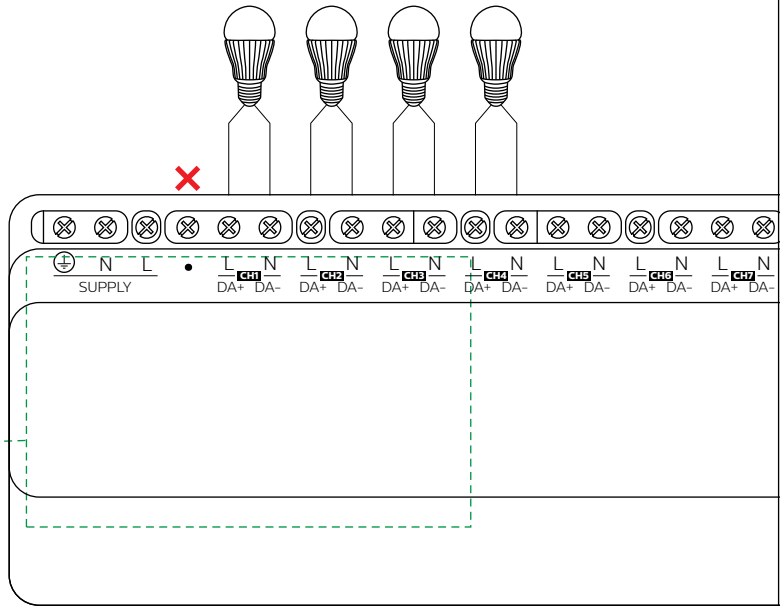
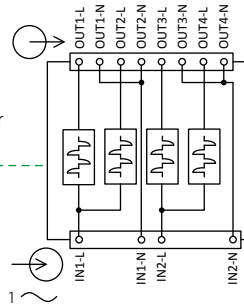

Load Type	Output Ratings Per Channel
Incandescent	2 A, 120 / 230 V ~
Magnetic with Halogen	2 A, 120 / 230 V ~
Electronic Driver*	2 A, 120 / 230 V ~

*can be limited by load capacitance
Apply de-rating for electronic and LED loads.

7 J



DGTM402
4 x 2 A
TE dimmer
module

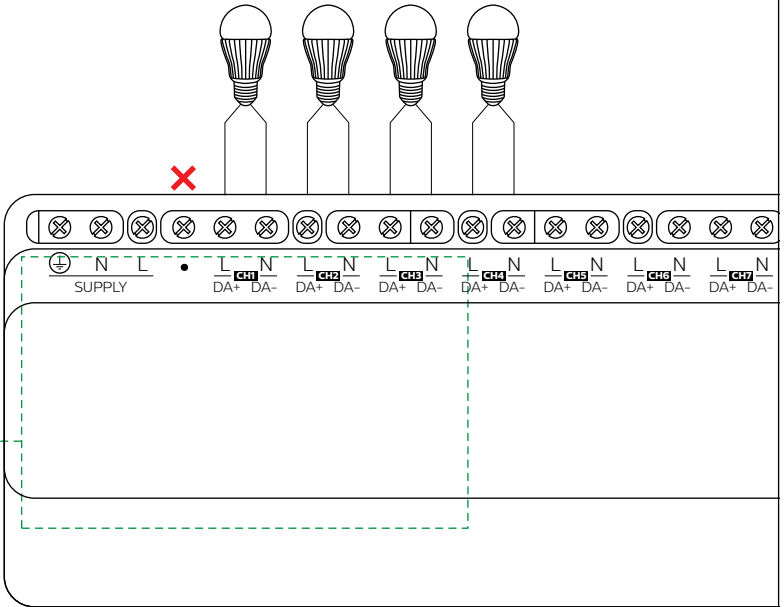
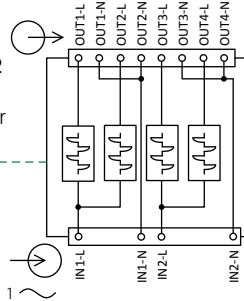

Load Type	Output Ratings Per Channel
Incandescent	2 A, 120 (UL) / 230 V ~
Electronic Driver	2 A, 120 (UL) / 230 V ~

Not compatible with magnetic transformers.
Apply de-rating for electronic and LED loads.

8

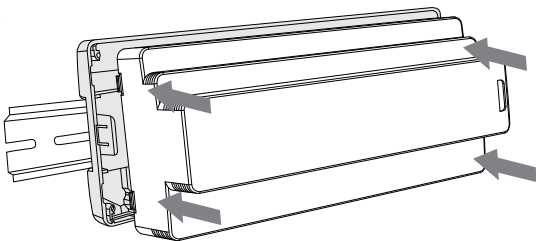

9

1 C 2 3 C 4 5 C 6 7 C 8

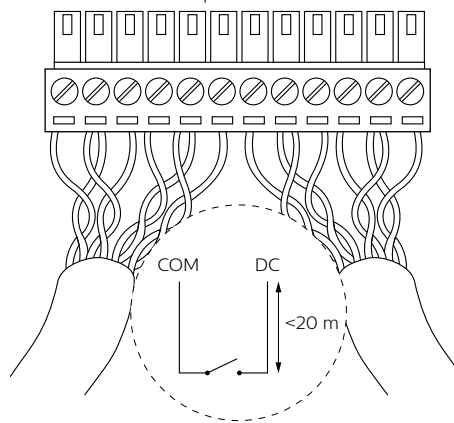
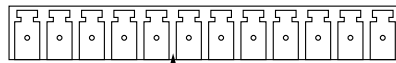

$\leq 1.3\text{ mm}^2$
 16 + AWG

0.34 Nm
(3.0 lb-in)

10 A

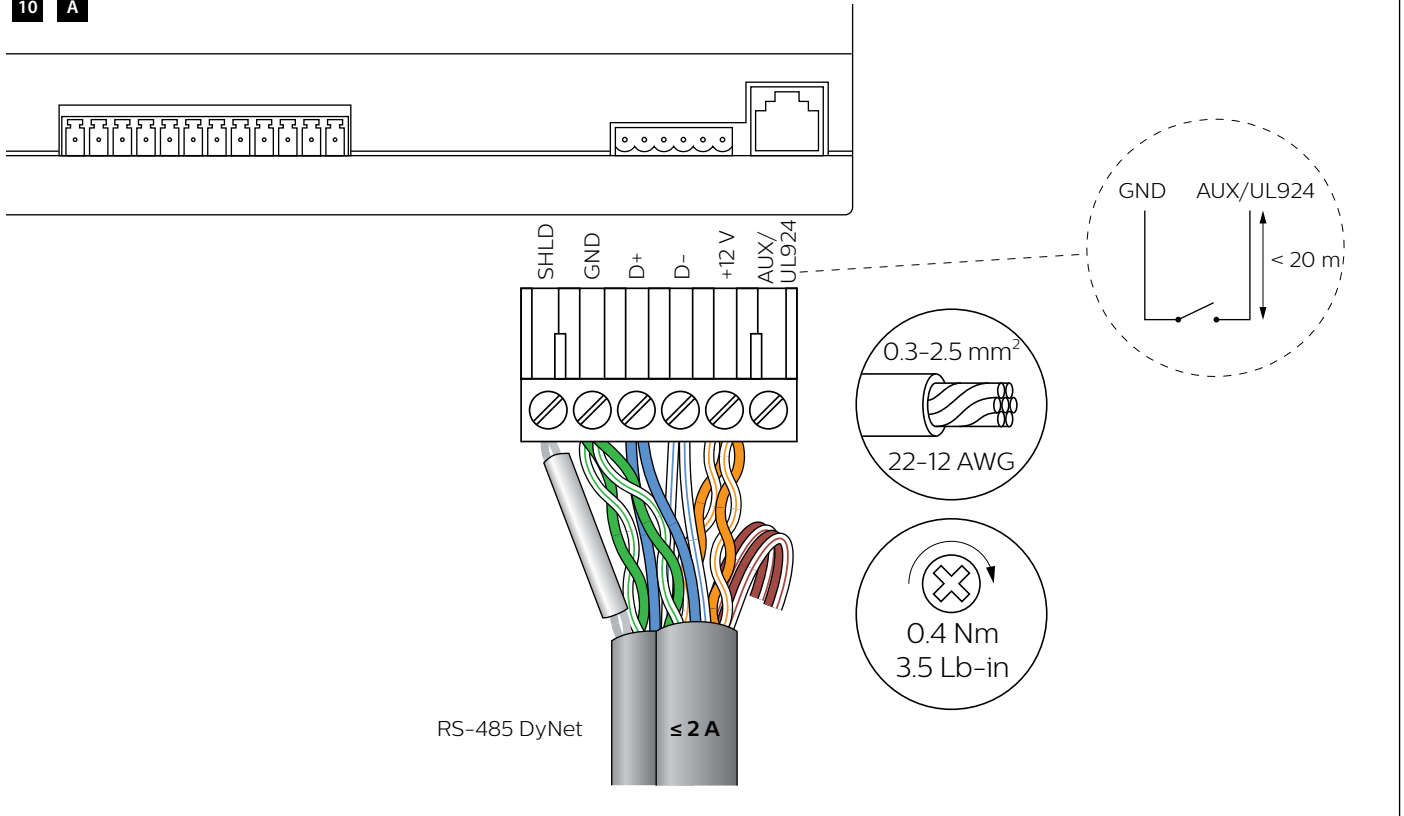

10 B

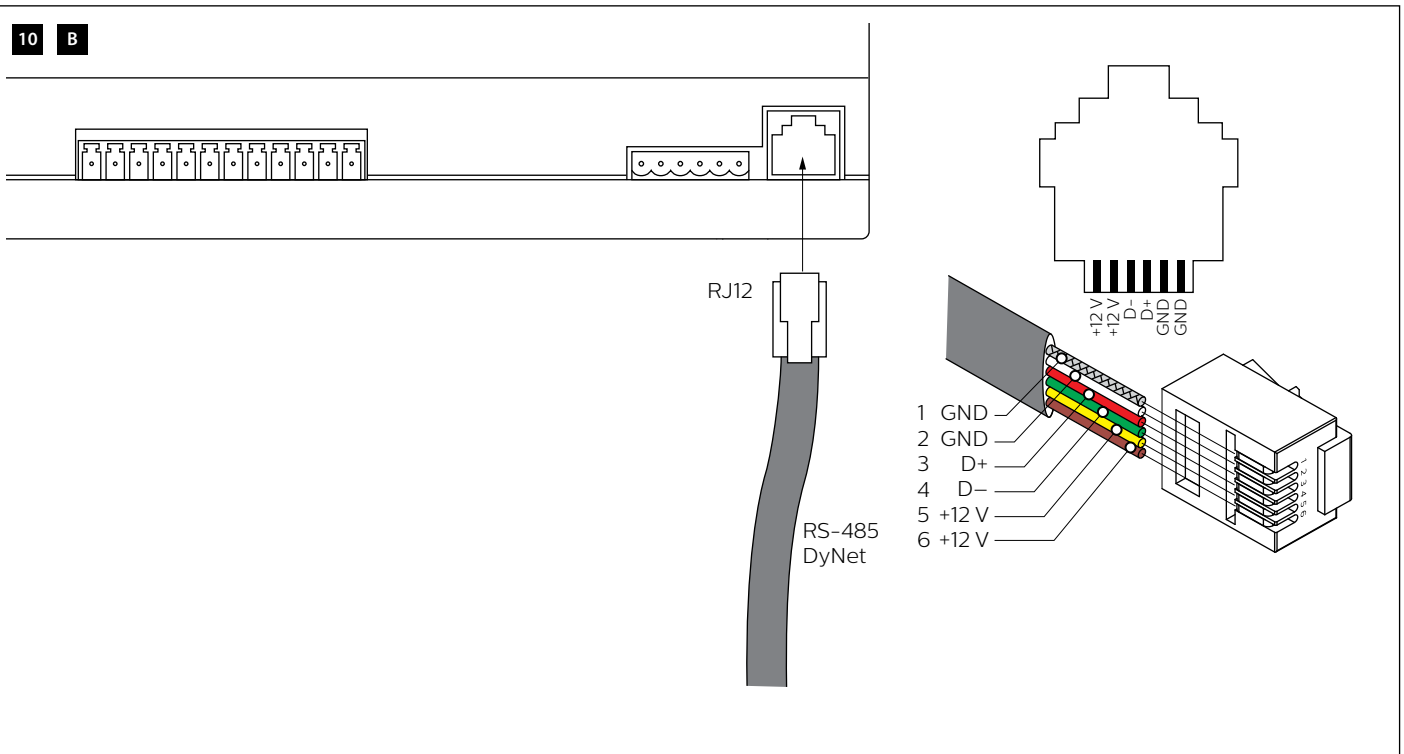

11 A

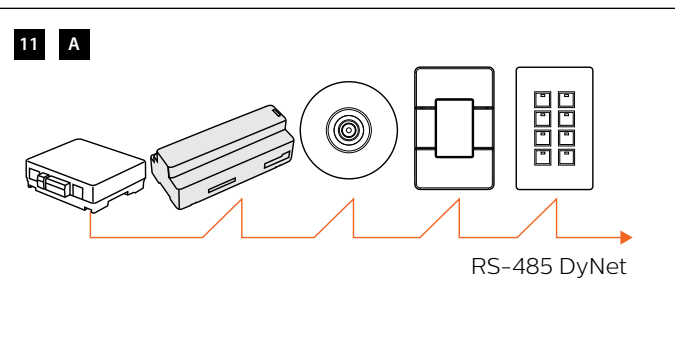

11 B

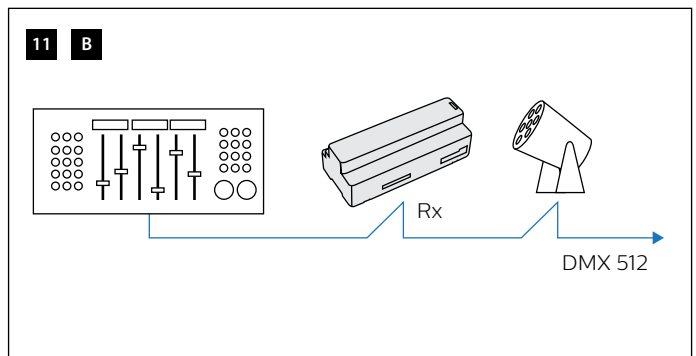

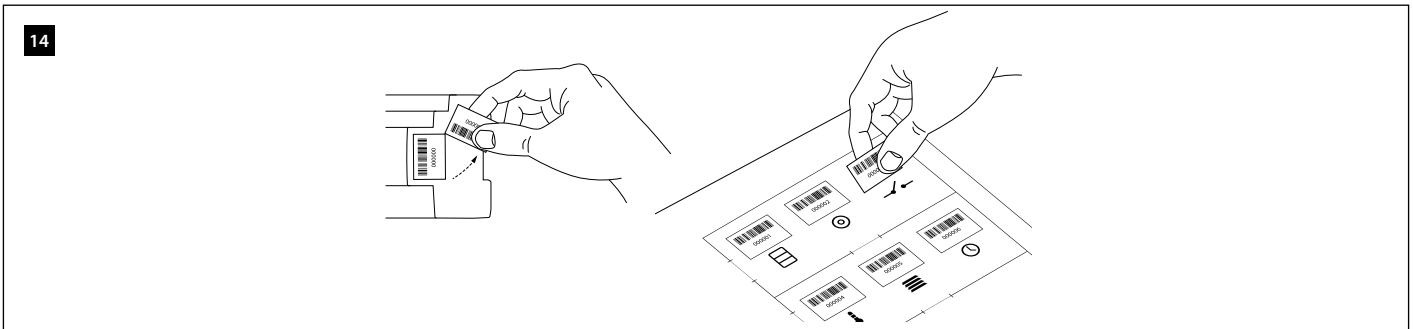
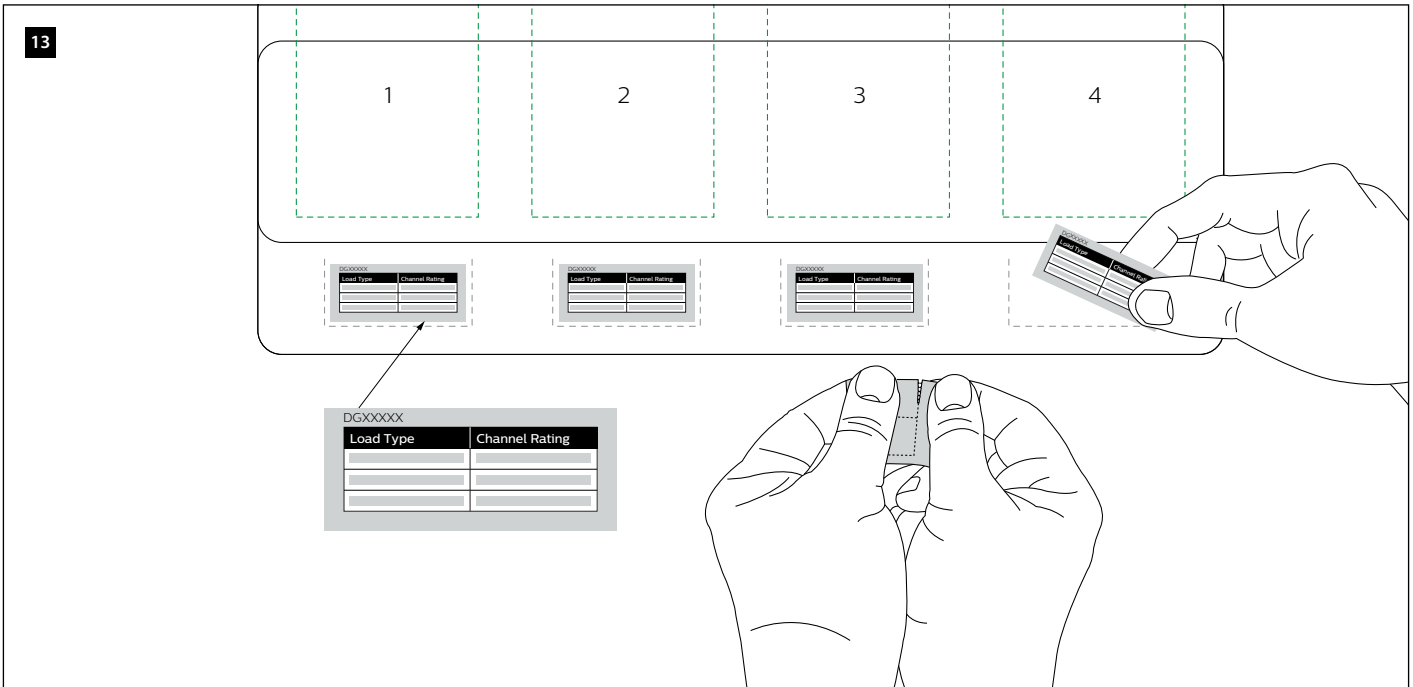
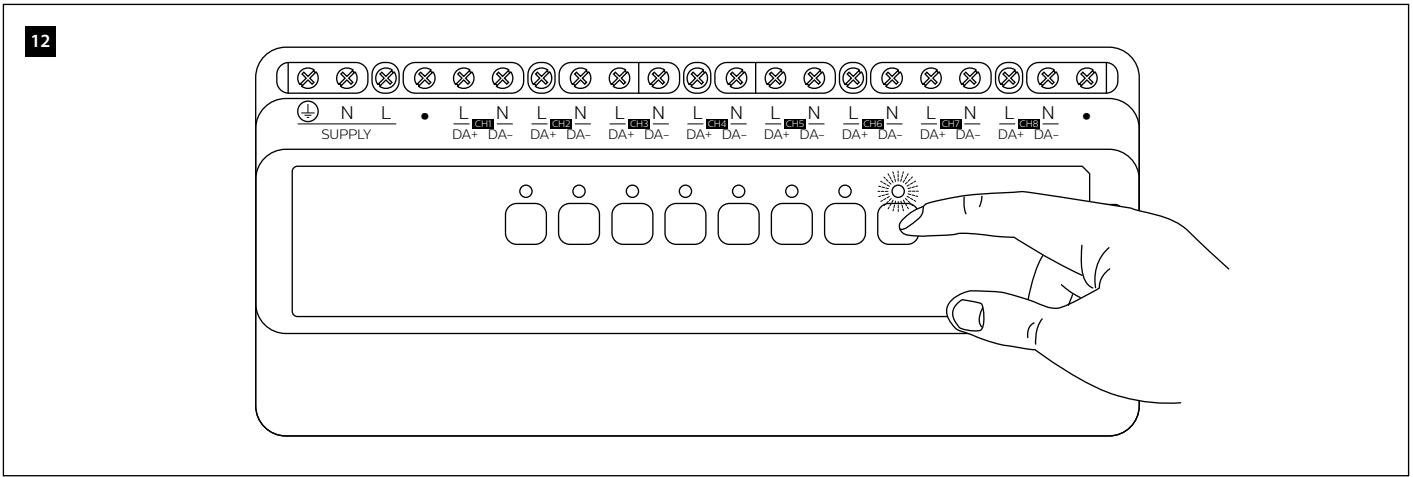

⚠ The manufacturer is not responsible for dimmable lamp selection. Each lamp/dimmer combination must be tested for compatibility prior to installation.

Federal Communications Commission (FCC) Compliance Notice: Radio Frequency Notice – This equipment has been tested and found to comply with the limits for a Class B digital device, pursuant to part 15 of the FCC Rules. These limits are designed to provide reasonable protection against harmful interference in a residential installation. This equipment generates, uses, and can radiate radio frequency energy and, if not installed and used in accordance with the instructions, may cause harmful interference to radio communications. However, there is no guarantee that interference will not occur in a particular installation. If this equipment does cause harmful interference to radio or television reception, which can be determined by turning the equipment off and on, the user is encouraged to try to correct the interference by one or more of the following measures: Reorient or relocate the receiving antenna. Increase the separation between the equipment and receiver. Connect the equipment into an outlet on a circuit different from that to which the receiver is connected. Consult the dealer or an experienced radio/TV technician for help. Any modifications not approved by the manufacturer of this device could void the user's authority to operate this device.

ⓘ This Class B digital apparatus complies with Canadian ICES-003: CAN ICES-3(B)/NMB-3(B). Cet appareil numérique de la classe B est conforme a la norme NMB-003 du Canada: CAN ICES-3(B)/NMB-3(B).

ⓘ Installation of a home and building automation and control system shall comply with HD 60364-4-41. The temperature limits and current-carrying capacities for the communication wires specified in HD 384.5.523 shall not be exceeded.

© 2021 Signify Holding. All rights reserved. Specifications are subject to change without notice. No representation or warranty as to the accuracy or completeness of the information included herein is given and any liability for any action in reliance thereon is disclaimed. Philips and the Philips Shield Emblem are registered trademarks of Koninklijke Philips N.V. All other trademarks are owned by Signify Holding or their respective owners.

