

















IP20 SELV                
RoHS

Driver LCI 35W 350mA–900mA TOP SR

TOP series

Product description

- Independent fixed output LED Driver
- Constant current LED Driver
- Output current settable 350 – 900 mA
- Max. output power 35 W
- Nominal life-time up to 100,000 h
- For luminaires of protection class I and protection class II
- For luminaires with M and MM as per EN 60598, VDE 0710 and VDE 0711
- Temperature protection as per EN 61347-2-13 C5e
- 5-year guarantee

Properties

- Casing: polycarbonate, white
- Type of protection IP20
- No tools required for installation
- Through wiring possible
- Integrated terminal cover and strain relief
- 5 separate strain reliefs
- Accessory LCF 12V FAN DRIVER fits into the secondary wiring area of the LED Driver

Functions

- Intelligent Temperature Guard (overtemperature protection)
- Intelligent Temperature Management (temperature monitoring of LED module)
- Short-circuit proof
- Overload protection
- Suitable for emergency escape lighting systems acc. to EN 50172

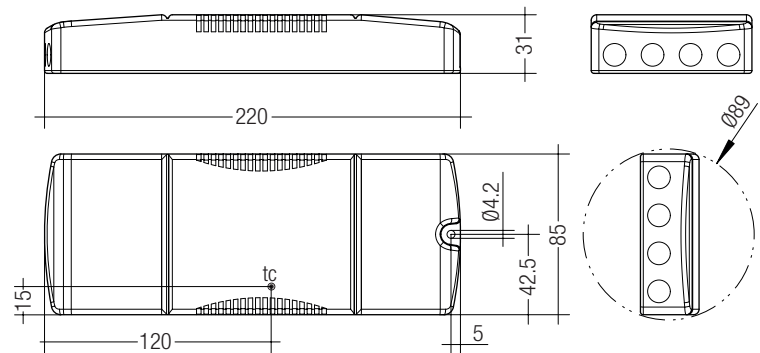

Ordering data

Type	Article number	Packaging carton	Packaging pallet	Weight per pc.
LCI 35W 350mA-900mA TOP SR	28000194	10 pc(s).	400 pc(s).	0.238 kg



Standards, page 5

Technical data

Rated supply voltage	220 – 240 V
AC voltage range	198 – 264 V
DC voltage range	176 – 280 V (start ≥ 198 V DC)
Mains frequency	0 / 50 / 60 Hz
Overvoltage protection	320 V AC, 48 h
Leakage current (PE)	< 0.5 mA
Max. input power	42 W
Efficiency (at 230 V, 50 Hz, full load)	88 – 90 %
THD (at 230 V, 50 Hz, full load)	< 10 %
Output current tolerance	± 5 %
Output LF current ripple (< 120 Hz)	< 2 %
Max. peak output current	Output current + 20 %
Max. output voltage (no-load voltage)	120 V
Time to light	< 0.5 s
Hold on time at power failure or switch-off	< 0.5 s
Switchover time (AC/DC)	< 0.5 s
Burst / surge peaks output side against PE	2 kV
Dimensions L x W x H	220 x 85 x 31 mm

Specific technical data

Type	Output current	Min. forward voltage	Max. forward voltage	Max. output power	Input power (at 230 V, 50 Hz, full load)	Input current (at 230 V, 50 Hz, full load)	λ (at 230 V, 50 Hz, full load)	tc point	Ambient temperature ta	tc/ta for ≥ 50.000 h	I sel resistor value
LCI 35W 350mA-900mA TOP SR	350 mA	40.5 V	90.0 V	31.5 W	35.3 W	159 mA	0.965	85 °C	-25 ... +65 °C	85 / 65 °C	open circuit
	400 mA	39.4 V	87.5 V	35.0 W	39.1 W	175 mA	0.97	80 °C	-25 ... +60 °C	80 / 60 °C	66.50 kΩ
	450 mA	35.0 V	77.8 V	35.0 W	39.7 W	178 mA	0.97	80 °C	-25 ... +55 °C	80 / 55 °C	57.60 kΩ
	500 mA	31.5 V	70.0 V	35.0 W	39.6 W	177 mA	0.97	80 °C	-25 ... +55 °C	80 / 55 °C	49.90 kΩ
	550 mA	28.6 V	63.6 V	35.0 W	39.7 W	178 mA	0.97	80 °C	-25 ... +55 °C	80 / 55 °C	42.20 kΩ
	600 mA	26.3 V	58.3 V	35.0 W	40.0 W	179 mA	0.97	80 °C	-25 ... +55 °C	80 / 55 °C	35.70 kΩ
	650 mA	24.2 V	53.8 V	35.0 W	39.9 W	178 mA	0.97	80 °C	-25 ... +55 °C	80 / 55 °C	28.70 kΩ
	700 mA	22.5 V	50.0 V	35.0 W	39.7 W	178 mA	0.97	80 °C	-25 ... +55 °C	80 / 55 °C	22.00 kΩ
	750 mA	21.0 V	46.7 V	35.0 W	39.3 W	176 mA	0.97	80 °C	-25 ... +55 °C	80 / 55 °C	15.00 kΩ
	800 mA	19.7 V	43.8 V	35.0 W	39.7 W	178 mA	0.97	80 °C	-25 ... +55 °C	80 / 55 °C	10.00 kΩ
	850 mA	18.5 V	41.2 V	35.0 W	39.7 W	178 mA	0.97	80 °C	-25 ... +55 °C	80 / 55 °C	5.36 kΩ
	900 mA	17.5 V	38.9 V	35.0 W	39.6 W	177 mA	0.97	75 °C	-25 ... +50 °C	75 / 50 °C	short circuit

Product description

- Ready-for-use resistor to set output current value
- Compatible with LED Driver series TOP and ECO
- Resistor is base isolated
- Resistor power 0.25 W
- Resistor value tolerance $\pm 1\%$

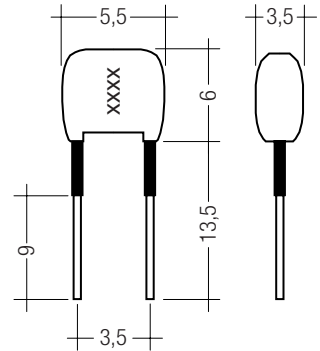
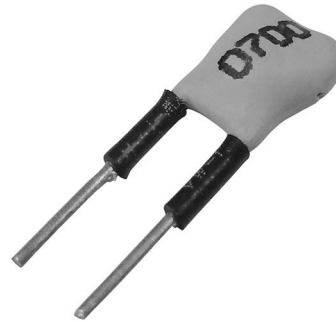

Ordering data

Type	Article number	Colour	Marking	Resistor value	Packaging bag	Weight per pc.
I-SELECT PLUG 400mA GN	28000451	Green	0400	66.50 k Ω	10 pc(s).	0.001 kg
I-SELECT PLUG 450mA GN	28000452	Green	0450	57.60 k Ω	10 pc(s).	0.001 kg
I-SELECT PLUG 500mA GN	28000277	Green	0500	49.90 k Ω	10 pc(s).	0.001 kg
I-SELECT PLUG 550mA GN	28000453	Green	0550	42.20 k Ω	10 pc(s).	0.001 kg
I-SELECT PLUG 600mA GN	28000454	Green	0600	35.70 k Ω	10 pc(s).	0.001 kg
I-SELECT PLUG 650mA GN	28000455	Green	0650	28.70 k Ω	10 pc(s).	0.001 kg
I-SELECT PLUG 700mA GN	28000278	Green	0700	22.00 k Ω	10 pc(s).	0.001 kg
I-SELECT PLUG 750mA GN	28000456	Green	0750	15.00 k Ω	10 pc(s).	0.001 kg
I-SELECT PLUG 800mA GN	28000457	Green	0800	10.00 k Ω	10 pc(s).	0.001 kg
I-SELECT PLUG 850mA GN	28000458	Green	0850	5.36 k Ω	10 pc(s).	0.001 kg
I-SELECT PLUG MAX GR	28000274	Grey	MAX	0 Ω	10 pc(s).	0.001 kg

Product description

- Fan driver module with 12.4 V output voltage
- Drives the fan permanently (independent of the optional temperature sensor)
- Terminal IN1 / IN2: stranded wires 0.2 mm², stripped wire endings twisted and tin-plated
- Terminal FAN+ / FAN- and OUT1 / OUT2: 0.2 – 0.75 mm² solid or stranded wires twisted and tin-plated, strip wires 6 – 7 mm
- Max. output power of the LED Driver will be reduced by the power consumption of the fan and LCF 12V FAN DRIVER



Technical data

Input voltage, DC	25 – 120 V
Output voltage DC	12.4 V
Max. output current (input voltage 25 – 49 V)	50 mA
Max. output current (input voltage 50 – 120 V)	70 mA
Max. power consumption incl. fan (at 30 mA)	0.55 W
Max. power consumption incl. fan (at 50 mA)	0.90 W
Max. power consumption incl. fan (at 70 mA)	1.25 W
tc point	75 °C
Ambient temperature ta (at life-time 50,000 h)	-25 ... +65 °C
Dimensions LxWxH	45 x 23 x 14 mm

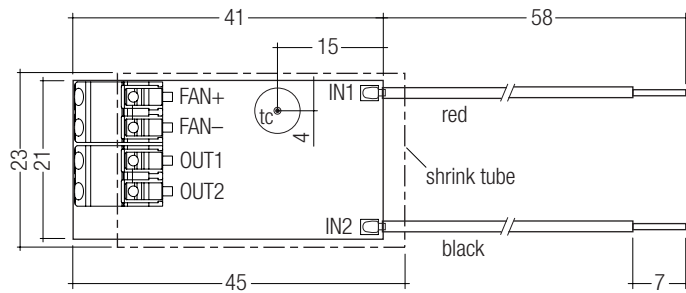

Ordering data

Type	Article number	Packaging carton	Packaging pallet	Weight per pc.
LCF 12V FAN DRIVER	28000932	50 pc(s).	1,200 pc(s).	0.01 kg

Standards

EN 55015
EN 61000-3-2
EN 61000-3-3
EN 61347-2-13
EN 62384
EN 61547
According to EN 50172 for use in central battery systems
According to EN 60598-2-22 suitable for emergency lighting installations

Output current setting

Output current can be set by connecting a resistor between the 2 "I sel" terminals. Relationship between output current and resistor value can be found at the table "Specific technical data". Resistor values specified from standardised resistor value ranges.
Resistor value tolerance has to be $\leq 1\%$.
Resistor power has to be $\geq 0.1\text{ W}$.
If the resistor is connected with wires a max. wire length of 2 m may not be exceeded and possible interferences have to be avoided.
Resistor detection at each start.
Change of the resistor value during the operation will be not considered.
Resistors for the main output current values can be ordered from Tridonic (see accessories).

DC emergency operation

The LED Driver is designed for operation on DC voltage and pulsed DC voltage.

Light output level in DC operation (EOF_x): 100 % (cannot be adjusted)

The voltage-dependent input current of Driver incl. LED module is depending on the used load.

The voltage-dependent no-load current of Driver (without or defect LED module) is for:
AC: < 28 mA
DC: < 9 mA

Overload protection

LED Driver will switch off at overload operation. Mains reset is required to restart the LED Driver.

Underload operation

LED Driver will switch off at underload operation. Mains reset is required to restart the LED Driver.

Overtemperature protection

The LED Driver will reduce output current at temporary thermal over-heating (exceeding max. tc point). On DC operation this function is deactivated to fulfill emergency requirements.

Short-circuit behaviour

LED Driver will switch off in case of short-circuit of LED output. Mains reset is required to restart the LED Driver.

No-load operation or load loss during operation

LED Driver will detect a load loss during operation. In this case and no-load operation the max. output voltage can apply at the LED output for max. 5 s before LED Driver shuts down. Mains reset is required to restart the LED Driver.

Hot plug-in

Hot plug-in is not recommend within 5 s after shutdown due to output voltage of > 0 V. Mains reset is required to restart the LED Driver if LED module is connected to the LED control gear after these 5 s.

Intelligent Temperature Management (ITM)

ITM offers the possibility to protect the LED module against thermal overload.
Therefore it is necessary to connect the temperature sensor (KTY81/210, KTY82/210) to the corresponding terminals.
If the limit temperature will be exceeded the LED output current will be reduced respectively switched off. After achieving the nominal temperature the LED output current will be increased to the set value again.
Using NTC or PTC resistors is not permitted.
The LED Driver can be used without sensor as well.

Conditions of use and storage

Humidity: 5 % up to max. 85 %, not condensed (max. 56 days/year at 85 %)

Storage temperature: -40 °C up to max. +80 °C

The devices have to be within the specified temperature range (ta) before they can be operated.

Glow-wire test

according to EN 60598-1 with increased temperature of 850 °C passed.

Temperature range

The LED Driver life duration is related to the ambient temperature ta. The relation of tc to ta temperature depends also on the luminaire design. If the measured tc temperature is approx. 5 K below tc max. or higher, ta temperature should be checked and eventually critical components (e.g. ELCAP) measured.
Detailed information on request.

Expected life-time

Type	Output current	ta	40 °C	50 °C	55 °C	60 °C	65 °C
LCI 35W 350mA-900mA TOP SR	350 mA	tc	60 °C	70 °C	75 °C	80 °C	85 °C
		life-time	>100,000 h	>100,000 h	>100,000 h	85,000 h	60,000 h
	400 mA	tc	60 °C	70 °C	75 °C	80 °C	x
		life-time	>100,000 h	>100,000 h	>100,000 h	85,000 h	x
	450 – 550 mA	tc	65 °C	75 °C	80 °C	x	x
		life-time	>100,000 h	>100,000 h	95,000 h	x	x
	600 mA	tc	65 °C	75 °C	80 °C	x	x
		life-time	>100,000 h	>100,000 h	90,000 h	x	x
	650 – 800 mA	tc	65 °C	75 °C	80 °C	x	x
		life-time	>100,000 h	>100,000 h	85,000 h	x	x
	850 mA	tc	65 °C	75 °C	80 °C	x	x
		life-time	>100,000 h	100,000 h	80,000 h	x	x
900 mA	tc	65 °C	75 °C	x	x	x	
	life-time	>100,000 h	100,000 h	x	x	x	

x = not permitted

The LED Driver is designed for a life-time stated above under reference conditions and with a failure probability of less than 10 %.

Maximum loading of automatic circuit breakers

Automatic circuit breaker type	C10	C13	C16	C20	B10	B13	B16	B20	Inrush current	
Installation Ø	1,5 mm ²	1,5 mm ²	2,5 mm ²	2,5 mm ²	1,5 mm ²	1,5 mm ²	2,5 mm ²	2,5 mm ²	I_{max}	time
LCI 35W 350mA-900mA TOP SR	35	45	55	70	35	45	55	70	9 A	40 µs

Harmonic distortion in the mains supply (at 230 V / 50 Hz and full load) in %

	THD	3.	5.	7.	9.	11.
LCI 35W 350mA-900mA TOP SR	10	7	4	3	3	2

Installation instructions

Mains supply wires

Wiring type and cross section
Stranded wire or solid wire up to 2.5 mm² may be used for wiring. Strip 10–11 mm of insulation from the cables to ensure perfect operation of the push terminals.
Use one wire for each terminal connector only.
Use each strain relief channel for one cable only.

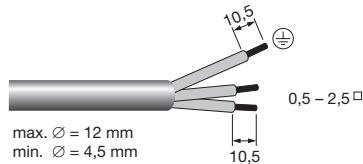

Secondary wires (LED module)

Wiring type and cross section
The wiring can be in stranded wires with ferrules or solid with a cross section of 0.2–1.5 mm².
Strip 8.5–9.5 mm of insulation from the cables to ensure perfect operation of the push-wire terminals.
Use one wire for each terminal connector only.
Use each strain relief channel for one cable only.

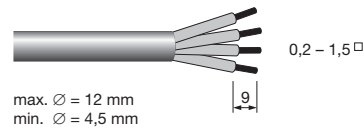

Fixing conditions

Dry, acidfree, oilfree, fatfree. It is not allowed to exceed the maximum ambient temperature (ta) stated on the device. Minimum distances stated below are recommendations and depend on the actual luminaire. Is not suitable for fixing in corner.

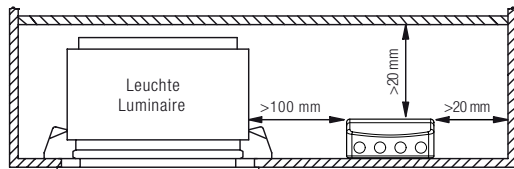

Release of the wiring

Press down the "push button" and remove the cable from front.

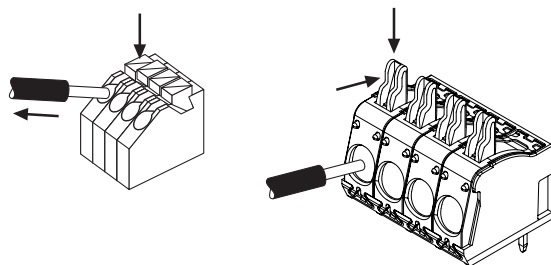

Wiring guidelines

- All connections must be kept as short as possible to ensure good EMI behaviour.
- Earthing is not required for the device to operate but will improve the EMI behaviour.
- If LCI TOP SR will be earthed protection earth (PE) has to be used.
- Mains leads should be kept apart from LED Driver and other leads (ideally 5 – 10 cm distance)
- Max. length of output and I sel wires is 2 m.
- Secondary switching is not permitted.
- Incorrect wiring can damage LED modules.
- Through wiring of mains is for connecting additional LED Driver only. Max. permanent current of 12 A may not be exceeded.
- The wiring must be protected against short circuits to earth (sharp edged metal parts, metal cable clips, louver, etc.).

Earth connection

The earth connection is conducted as protection earth (PE). If the LED driver will be earthed, protection earth (PE) has to be used. There is no earth connection required for the functionality of the LED Driver. Earth connection is recommended to improve following behaviour.

- Electromagnetic interferences (EMI)
- Transmission of mains transients to the LED output

In general it is recommended to earth the LED Driver if the LED module is mounted on earthed luminaire parts respectively heat sinks and thereby representing a high capacity against earth.

Isolation and electric strength testing of luminaires

Electronic devices can be damaged by high voltage. This has to be considered during the routine testing of the luminaires in production.

According to IEC 60598-1 Annex Q (informative only!) or ENEC 303-Annex A, each luminaire should be submitted to an isolation test with 500V_{DC} for 1 second. This test voltage should be connected between the interconnected phase and neutral terminals and the earth terminal.

The isolation resistance must be at least 2 MΩ.

As an alternative, IEC 60598-1 Annex Q describes a test of the electrical strength with 1500 V_{AC} (or 1.414 x 1500 V_{DC}). To avoid damage to the electronic devices this test must not be conducted.

Additional information

Additional technical information at www.tridonic.com → Technical Data

Guarantee conditions at www.tridonic.com → Services

Life-time declarations are informative and represent no warranty claim. No warranty if device was opened.

Circuit diagram

220–240 V
0/50/60 Hz

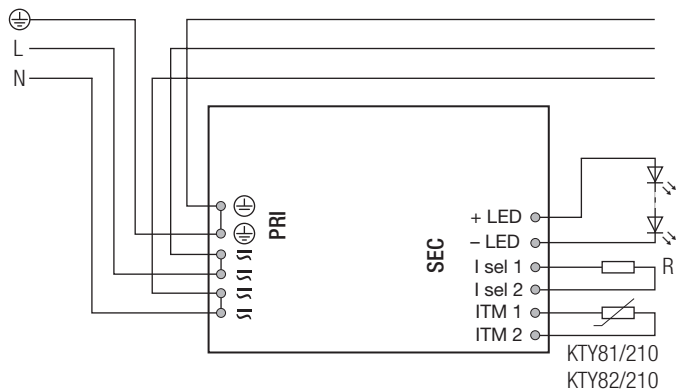

220–240 V
0/50/60 Hz

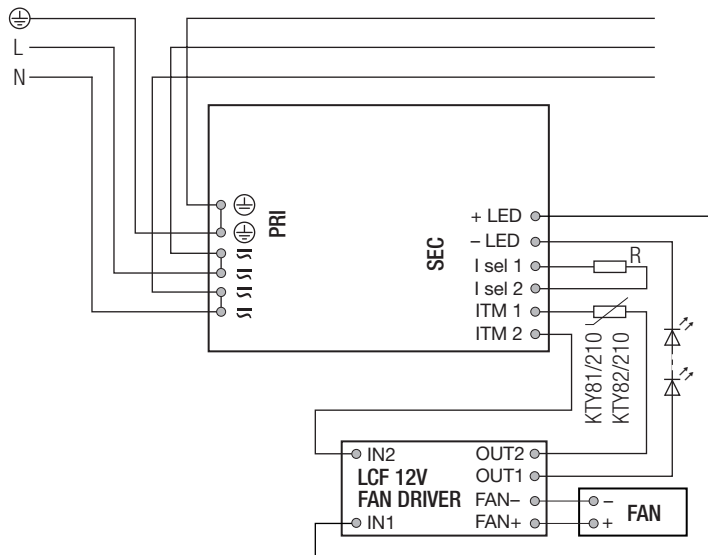

Diagrams LCI 35W 350mA-900mA TOP SR

Efficiency vs load

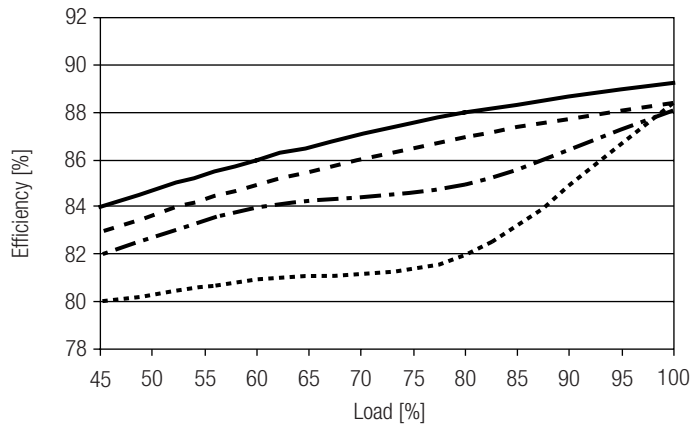

Power factor vs load

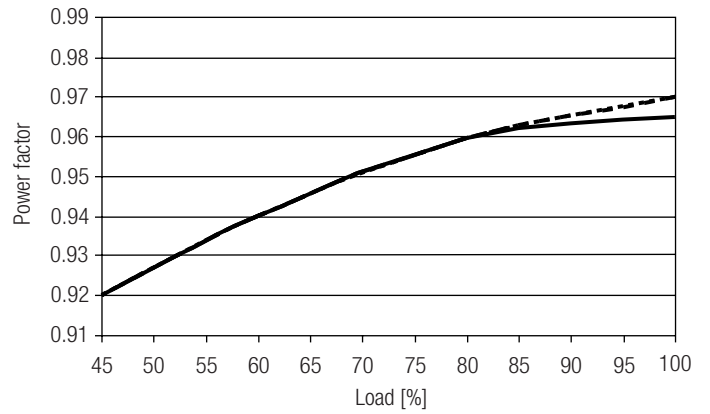

Input power vs load

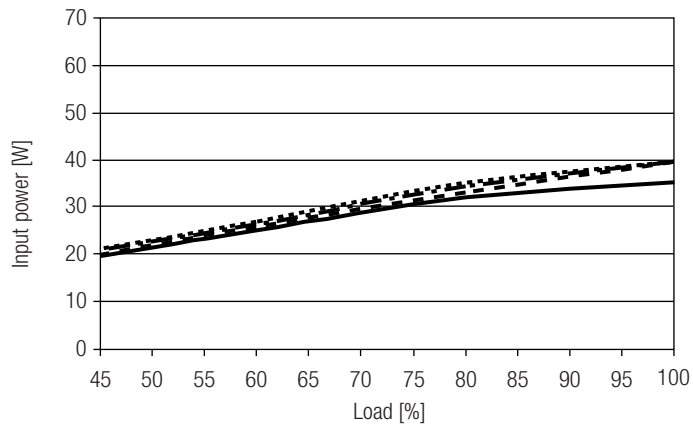

Input current vs load

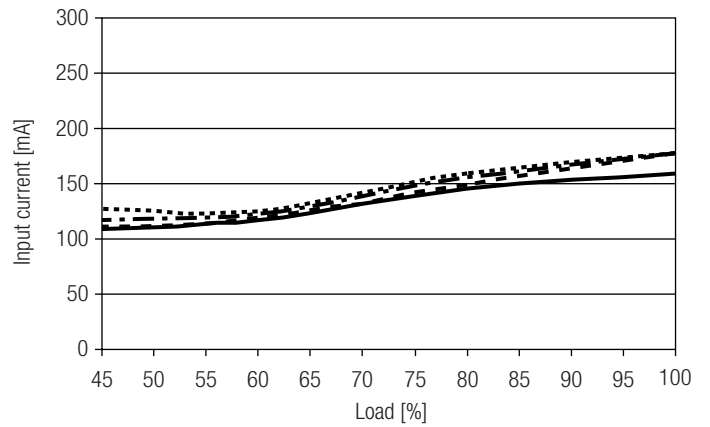

THD vs load

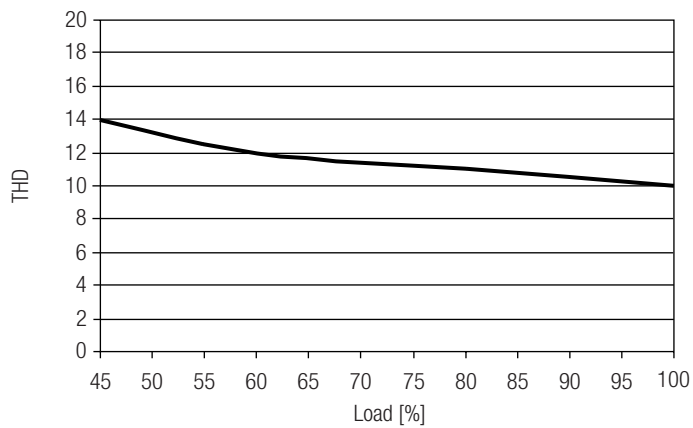

- 350 mA
- - - 500 mA
- · - · 700 mA
- · · · 900 mA