



DMC2

Installation Guide

Version 1.0

PHILIPS
dynalite 

Contents

DMC2	1
1 Product Overview	5
1.1 <i>DMC2 Enclosure</i>	6
1.1.1 Dimensions	6
1.1.2 Enclosure diagram	7
1.2 <i>DSM2-XX</i>	8
1.2.1 Dimensions / Diagrams	8
1.3 <i>DMD31X Module</i>	9
1.3.1 Dimensions	9
1.3.2 DMD31X module output wiring	10
1.4 <i>DMP310-GL</i>	11
1.4.1 Dimensions / Diagrams	11
1.5 <i>DMR310 / DMR316</i>	12
1.5.1 Dimensions / Diagrams	12
2 Installation	13
2.1 <i>Installation requirements</i>	13
2.2 <i>Cabling</i>	15
2.3 <i>Mounting the DMC2</i>	16
2.4 <i>Inserting and connecting modules</i>	17
2.4.1 DCM-DyNet	19
2.4.2 DSM2-XX	20
2.4.3 Control module installation	22
2.4.4 Wiring loom	24
3 Post-installation testing	25
3.1 <i>Service LEDs and switch</i>	25
3.2 <i>Manual override keypad</i>	26

About this Guide

Overview

This guide is designed to assist in the installation of the DMC2 Modular Controller.

A working knowledge of Dynalite commissioning processes is required to effectively use this document. For more information on the commissioning process, consult the DMC2 Commissioning Guide.

Disclaimer

These instructions have been prepared by Philips Dynalite and provide information on Philips Dynalite products for use by registered owners. Some information may become superseded through changes to the law and as a result of evolving technology and industry practices.

Any reference to non- Philips Dynalite products or web links does not constitute an endorsement of those products or services.

Copyright

© 2015 Dynalite, DyNet and associated logos are the registered trademarks of Koninklijke Philips Electronics N.V. All other trademarks and logos are the property of their respective owners.

1 Product Overview

The Philips Dynalite DMC2 is a versatile modular controller that consists of a power supply module, communication module, and up to two interchangeable control modules.

The power and communication modules are listed below:

- DSM2-XX – Single-phase or three-phase supply module that supplies power to the communications and control modules.
- DCM-DyNet – Communications module that supports DyNet, DMX Rx, dry contact inputs and UL924 input.

A variety of control modules provide simultaneous control of multiple load types and capacities:

- DMD – Driver control module for 1-10V, DSI and DALI drivers.
- DMP – Phase control dimmer module for Leading or Trailing Edge output, suitable for use with most types of dimmable electronic drivers.
- DMR – Relay control module for most types of switched loads.

The DMC2 can be surface or recess-mounted, and features a number of cabling knockouts to accommodate a variety of communication, supply and load configurations.

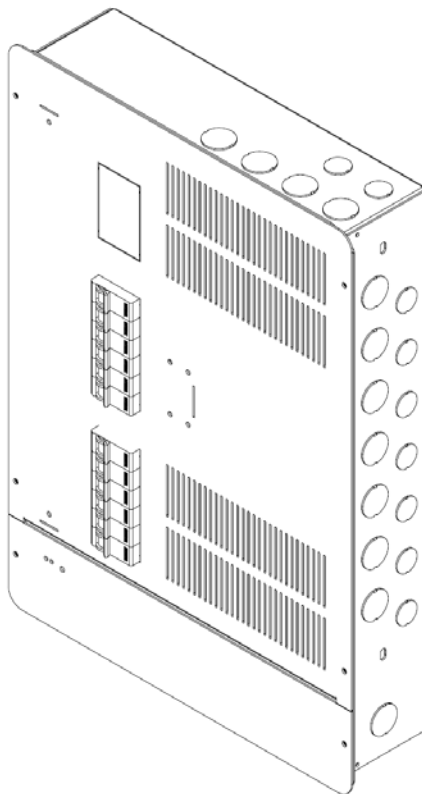

1.1 DMC2 Enclosure

The DMC2 enclosure is a galvanized steel case with powder coated front covers. It includes mounting bays for power supply module, communication module and two output modules.

1.1.1 Dimensions

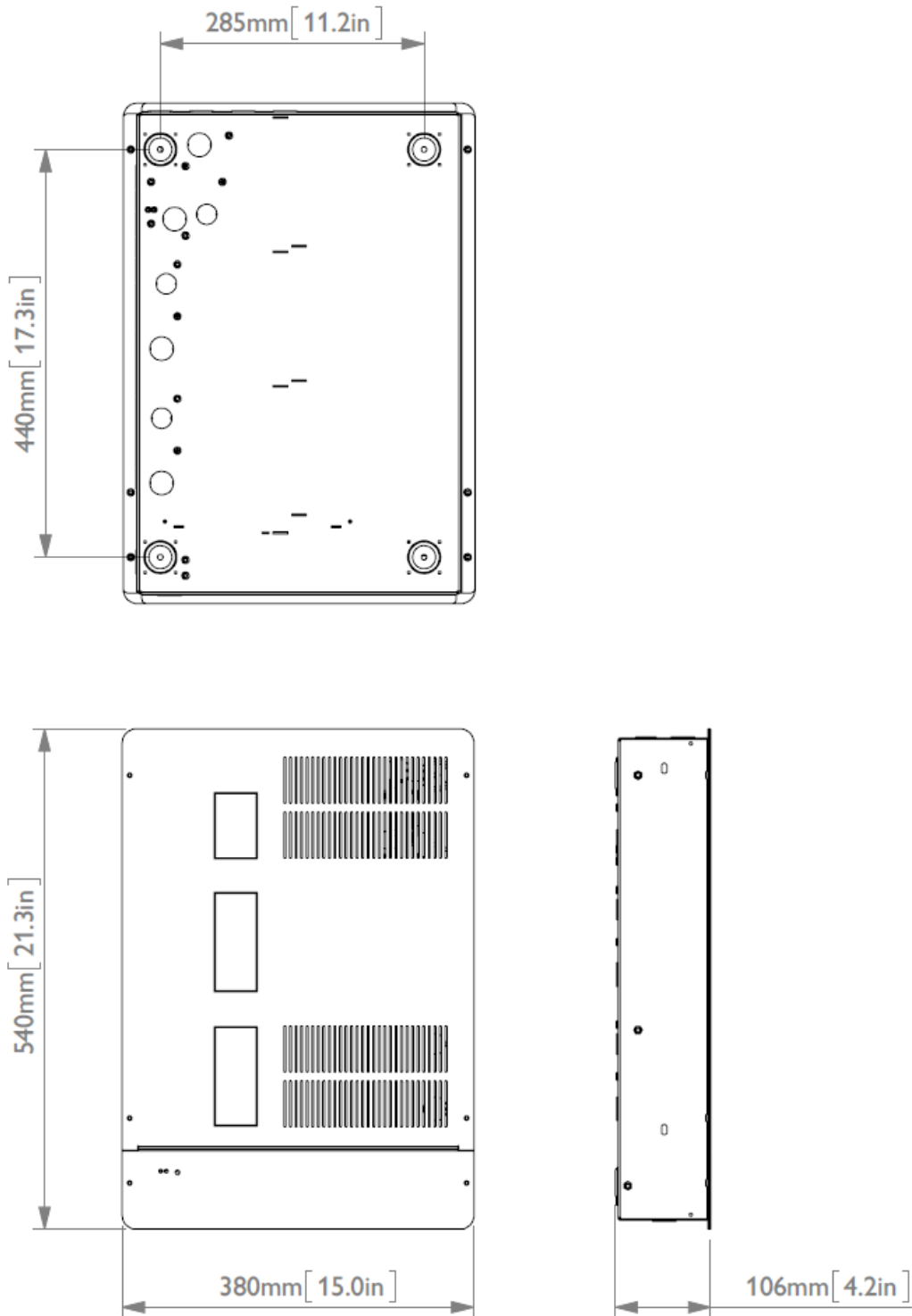

1.1.2 Enclosure diagram

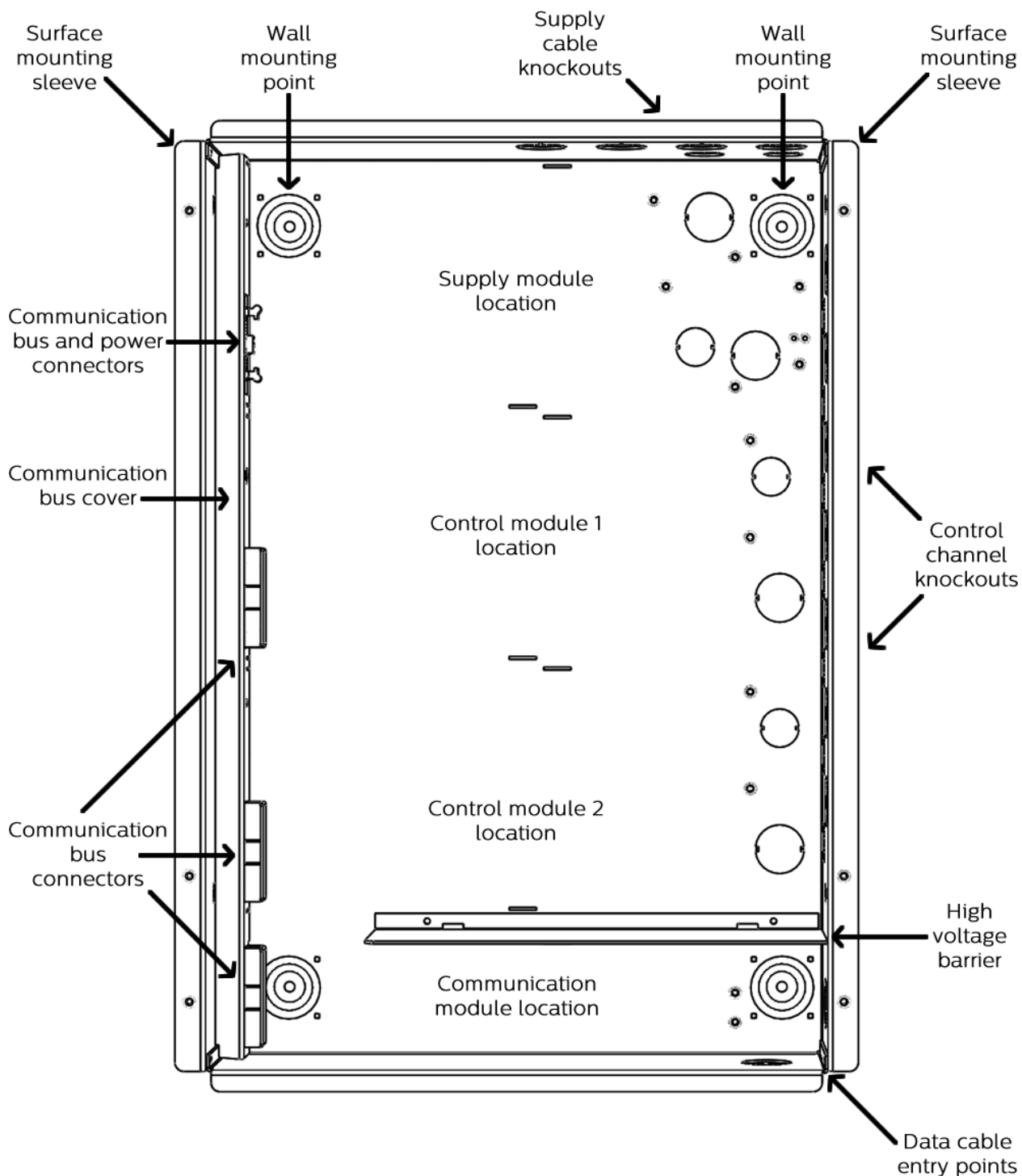

1.2 DSM2-XX

The DSM2-XX fits into the top module bay of the enclosure, and supplies power to the communication and control modules.

1.2.1 Dimensions / Diagrams

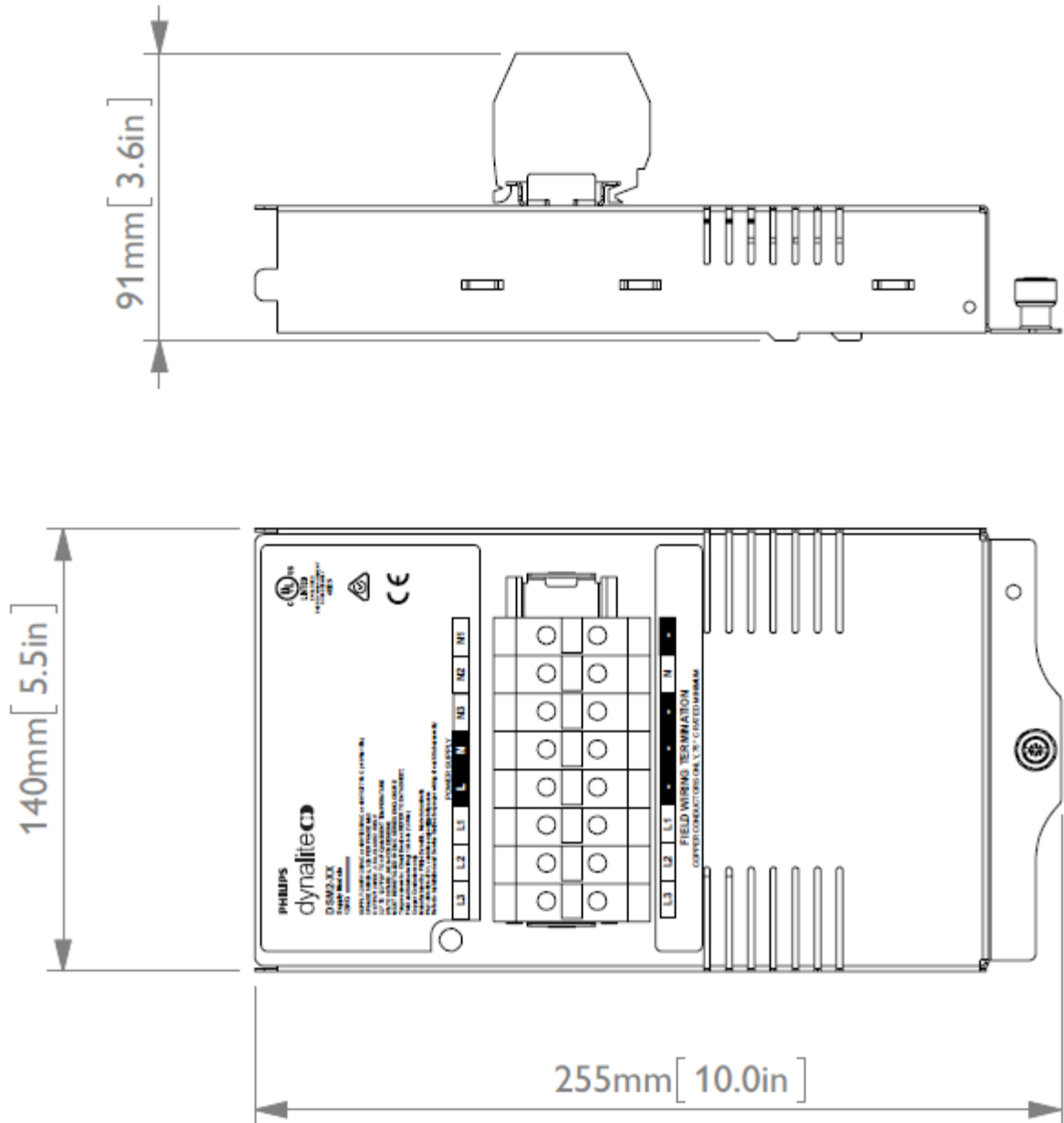

1.3 DMD31X Module

The DMD31X module is a three-channel signal controller. Each channel is individually configurable to DALI Broadcast, I-10V or DSI.

1.3.1 Dimensions

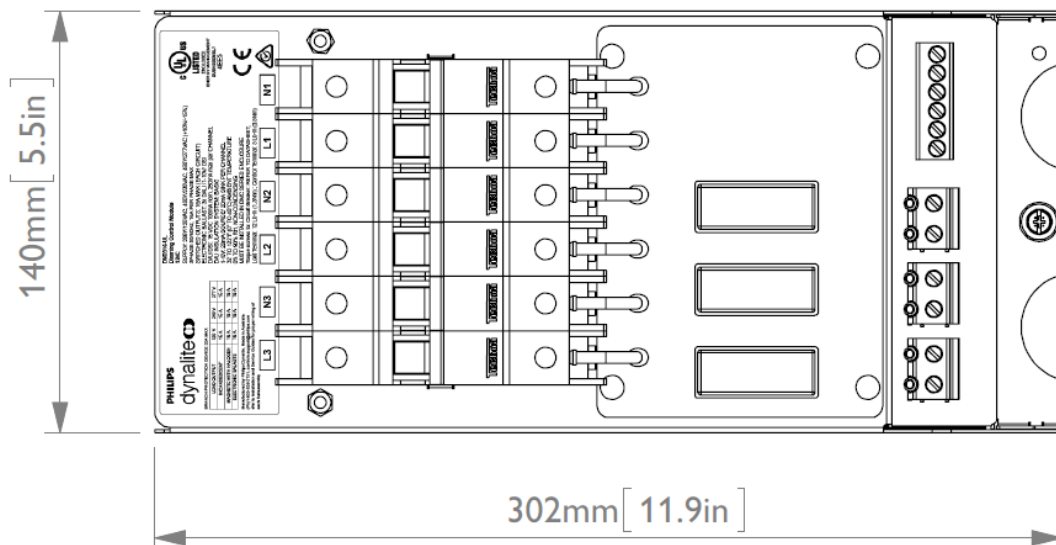
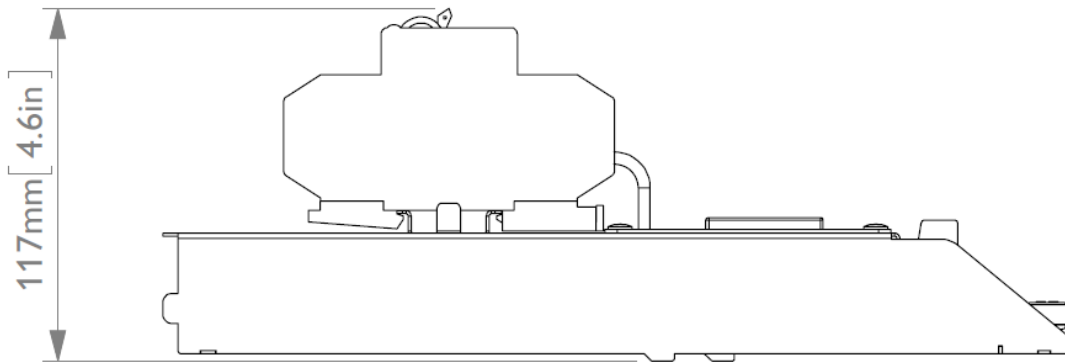

1.3.2 DMD31X module output wiring

The control signal must be terminated into the top six terminals on the module. The power circuit must be terminated into the bottom six terminals as indicated in the diagram below. Ensure that each signal and power channel has been paired and segregated correctly.

For installation involving 120 VAC circuits only:

Wire all output circuits using conductors suitable for Class I / Light and Power circuits rated 150 V minimum. The signal control circuit conductors can be intermingled with the branch circuit wiring in the wire trough. The signal control circuit conductors can be considered as Class 2 conductors. Class 2 wiring methods can be used for the signal control circuit outside the DMC control panel.

For installation involving 240 or 277 VAC circuits:

Wire all output circuits using conductors suitable for Class I / Light and Power circuits rated 300V min. The signal control circuit conductors can be intermingled with the branch circuit wiring in the wire trough. The signal control circuit conductors are to be considered as Class I conductors. Class I / Light and Power wiring methods must be used for the signal control circuit outside the DMC control panel.

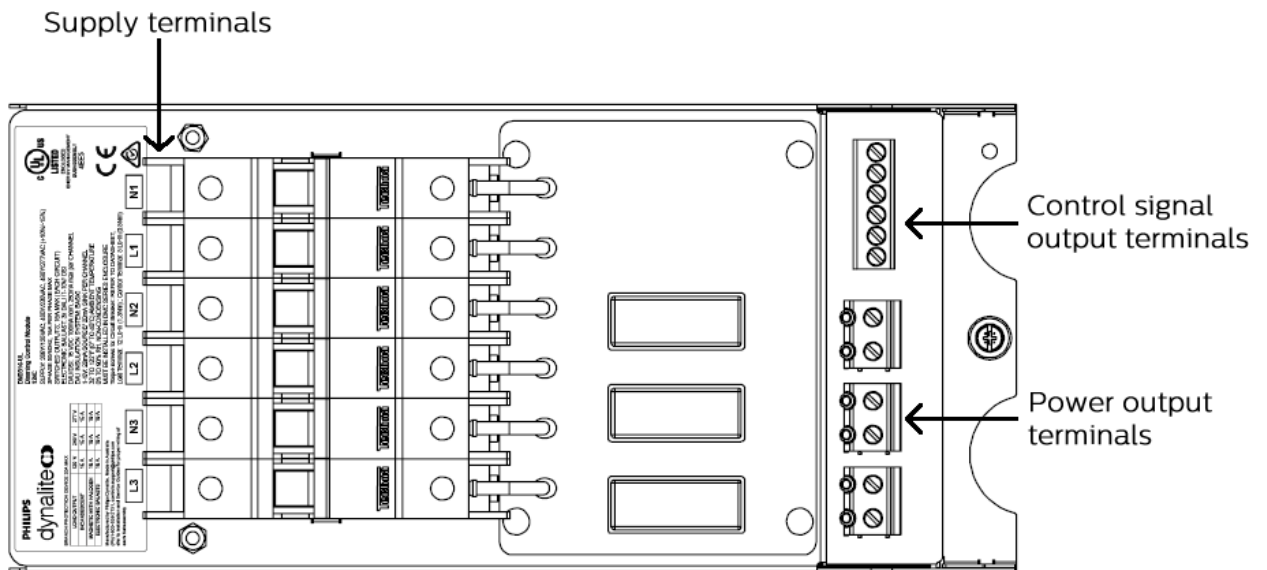

1.4 DMP310-GL

The DMP310-GL is a phase-cut dimming controller, software-selectable between leading edge and trailing edge, and is compatible with most dimmable drivers.

1.4.1 Dimensions / Diagrams

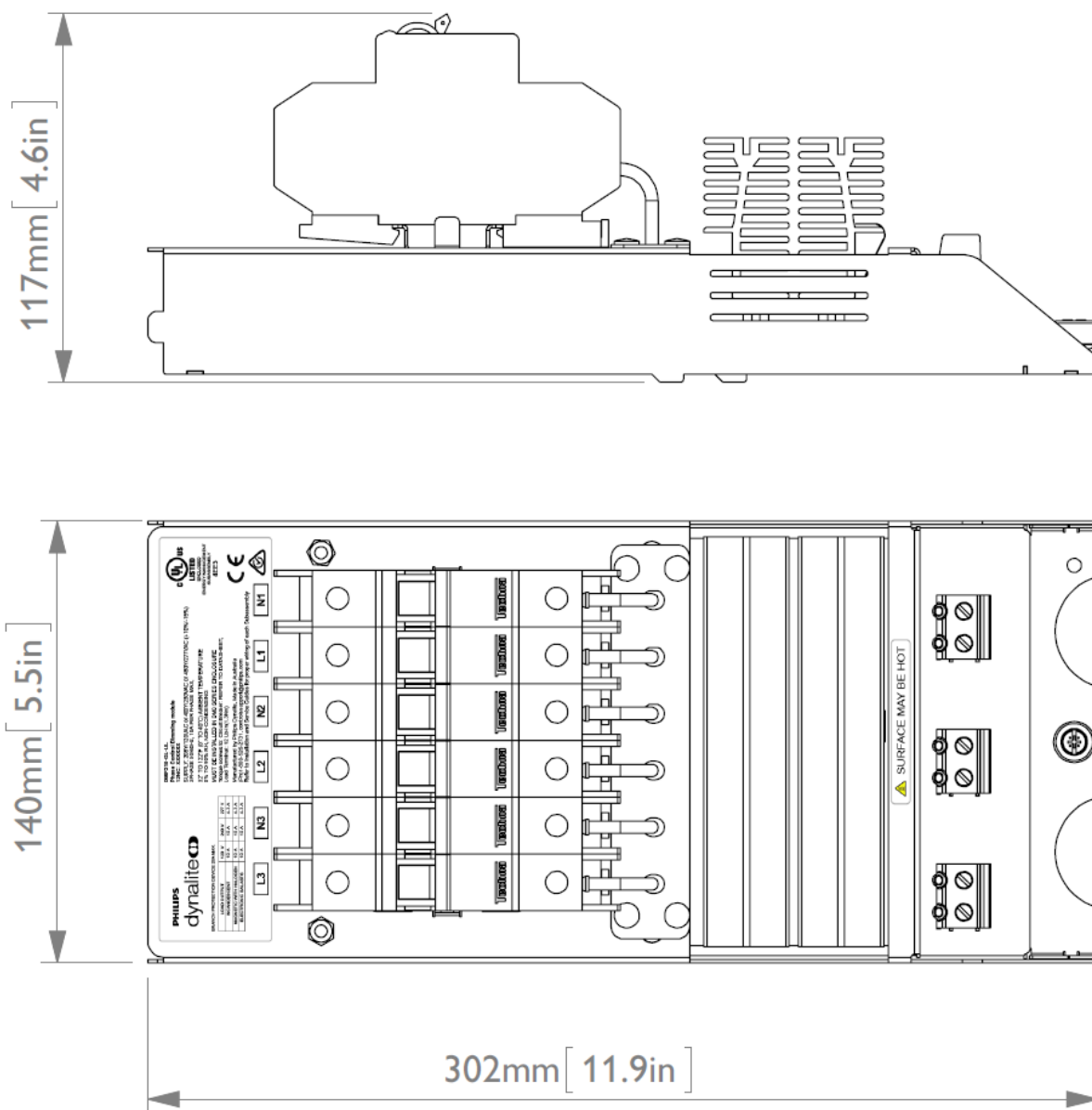

1.5 DMR31X

The DMR31X module is a three-channel relay controller, capable of controlling most types of switched loads, including lighting and motor control.

1.5.1 Dimensions / Diagrams

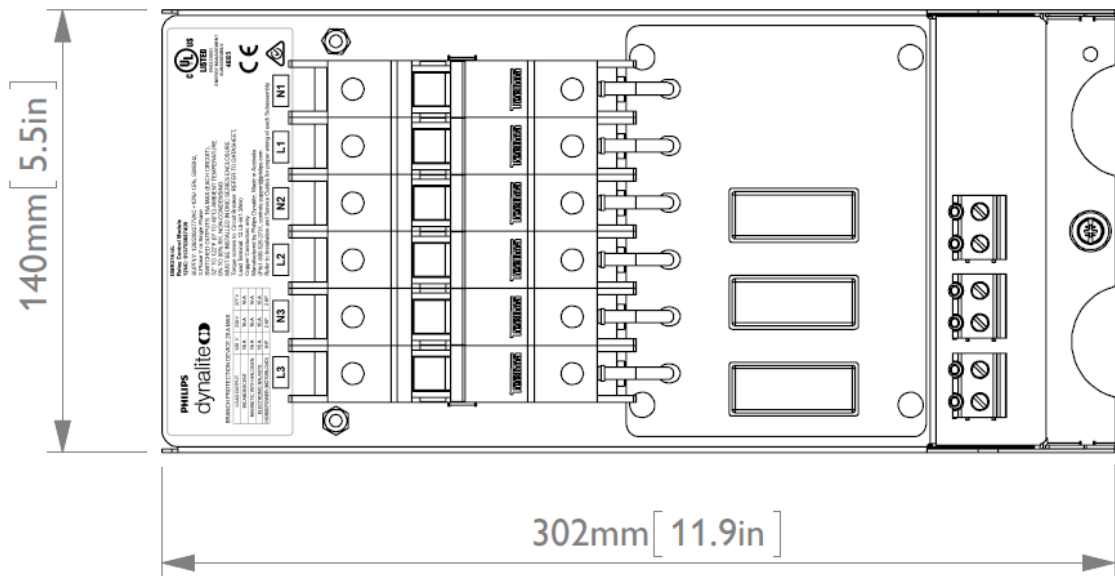
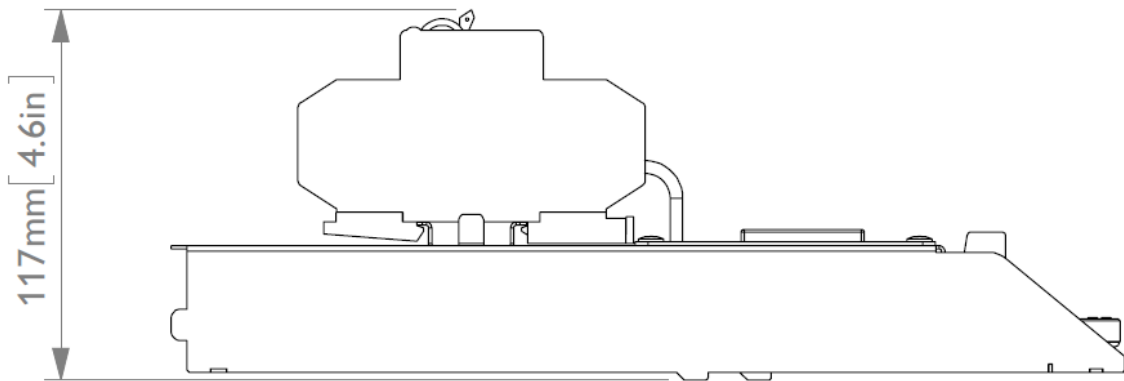

2 Installation

The DMC2 enclosure and modules are shipped separately and assembled onsite. This section describes the requirements and procedure for mounting and assembly.

Installation Overview

1. Confirm that all installation requirements are met
2. Remove knockout plates for cabling
3. Mount enclosure
4. Install modules
5. Connect cabling
6. Energize and test unit

2.1 Important Information

WARNING: Isolate from mains supply before terminating or adjusting any terminals. No serviceable parts inside. Service by qualified personnel only.

We recommend that you read this entire document prior to commencement of installation. Do not energize the DMC until all the installation steps detailed in this chapter are complete.

Installation of the home and building automation and control system shall comply with HD60364-4-41 where applicable.

Once assembled, powered and terminated correctly, this device will operate in basic mode. A new Philips Dynamlite user interface on the same network will turn all output lighting channels on from button 1 and off from button 4 allowing testing of network cables and terminations. Advanced functions and custom presets can then be configured via the EnvisionProject commissioning software.

If commissioning services are required, contact your local distributor for details.

This device should only be operated from the type of supply specified on installed modules. This device must be earthed.

Do not Megger test any circuitry connected to the dimming system, as damage to the electronics may result.

WARNING: The DMC must be de-energized before terminating the control and data cables.

2.2 Installation requirements

The DMC2 is designed for indoor use only. If installed in an outdoor location, the DMC2 must be housed in a suitable well-ventilated enclosure. Choose a dry location that will be accessible after the installation is complete.

To ensure sufficient cooling, you must mount the DMC2 vertically, as shown below.

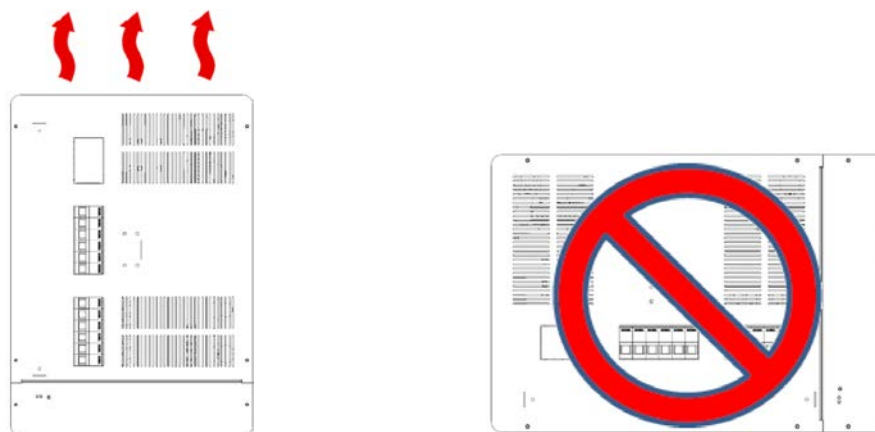

The DMC2 requires an air gap of at least 200mm (8 inches) on all sides of the front cover for adequate ventilation. This gap also ensures that the device is serviceable while still mounted.

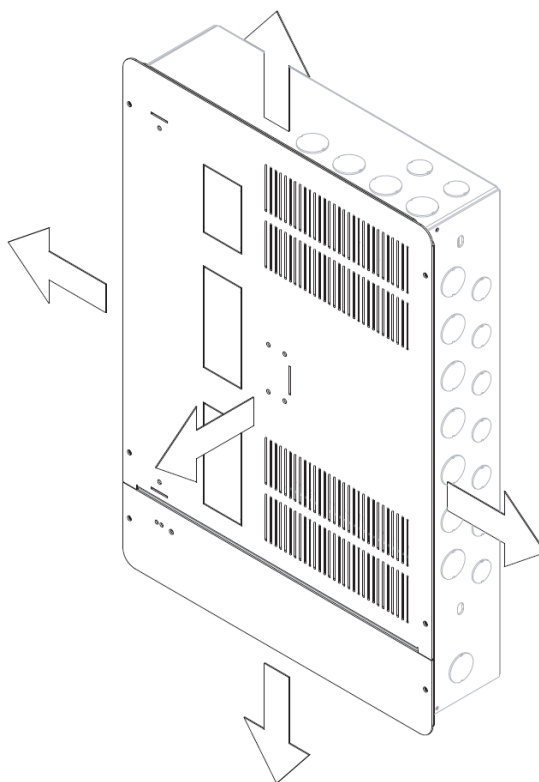

During operation the DMC2 may emit some audible noise such as humming or relay chatter. Take this into account when choosing the mounting location.

2.3 Cabling

Remove the required knockout plates for the supply cables before mounting the enclosure.

The DMC2 includes the following cabling knockouts. Cables should enter the enclosure through the nearest knockout to the relevant module.

Supply/Control:	Top:	4 x 28.2mm (1.1")	2 x 22.2mm (0.87")
	Side:	7 x 28.2 (1.1")	7 x 22.2mm (0.87")
	Back:	4 x 28.2mm (1.1")	3 x 22.2mm (0.87")
Data:	Side:	1 x 28.2mm (1.1")	
	Bottom:	1 x 28.2mm (1.1")	

The 28.2mm (1.1") knockouts are suitable for 3/4" conduit, while the 22.2mm (0.87") knockouts are suitable for 1/2" conduit.

The recommended cable for connections to the serial port is screened stranded RS485 compatible CAT-5E data cable with three twisted pairs. Refer to the Installation Instructions for the communication module for more cabling information. This cable must be segregated from mains and Class I cables as per local electrical code. If anticipated cable runs are over 600 meters for serial cables, consult your dealer for advice. Do not cut or terminate live data cables.

The DSM2-XX module input terminals accept supply cables up to 16mm². Supply cables should have a capacity of 32A per phase for three-phase supply or up to 63A for single phase to allow the device to be loaded to its maximum capacity. The Earth bar is located in DMC unit near the top of case.

If mounting the unit to a cable tray or a Unistrut-style product, you can route cables between the unit and the mounting surface to enter the enclosure via the knockouts on the rear face.

Control/communication cables enter at the bottom of the enclosure. Never run control cables through the mains voltage section of the enclosure.

WARNING: Do not remove any labels or stickers from cables, wiring, modules or other components in the DMC. Doing so may violate local safety regulations.

2.4 Mounting the DMC2

The DMC2 can be surface or recess mounted.

Surface mounting uses four mounting points, indicated below:

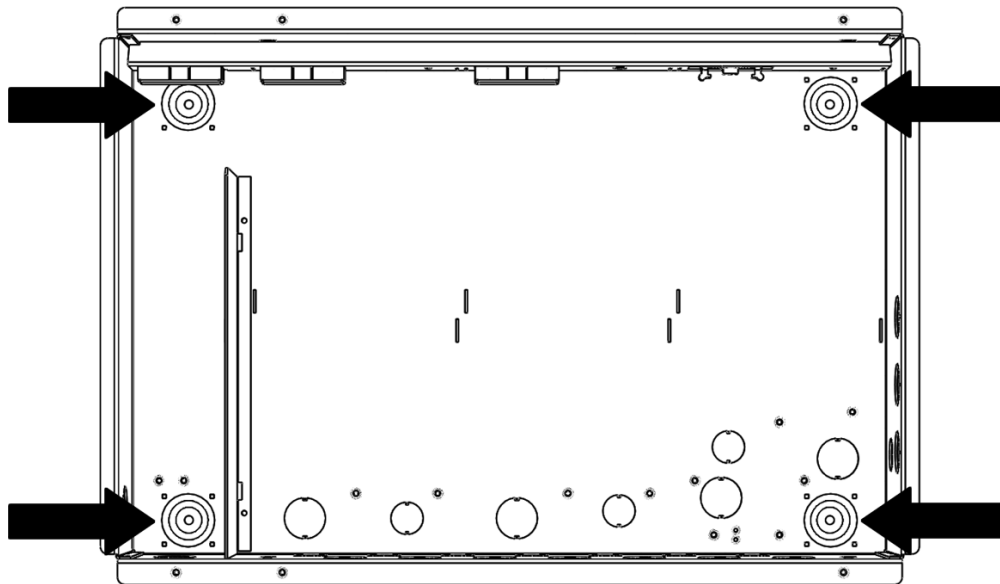

Recess mounting is supported by four mounting holes suitable for M6 (1/4") fasteners, two on either side of the enclosure as shown below.

The minimum spacing between studs is 380mm (15"), and the minimum mounting depth is 103mm (4.1").

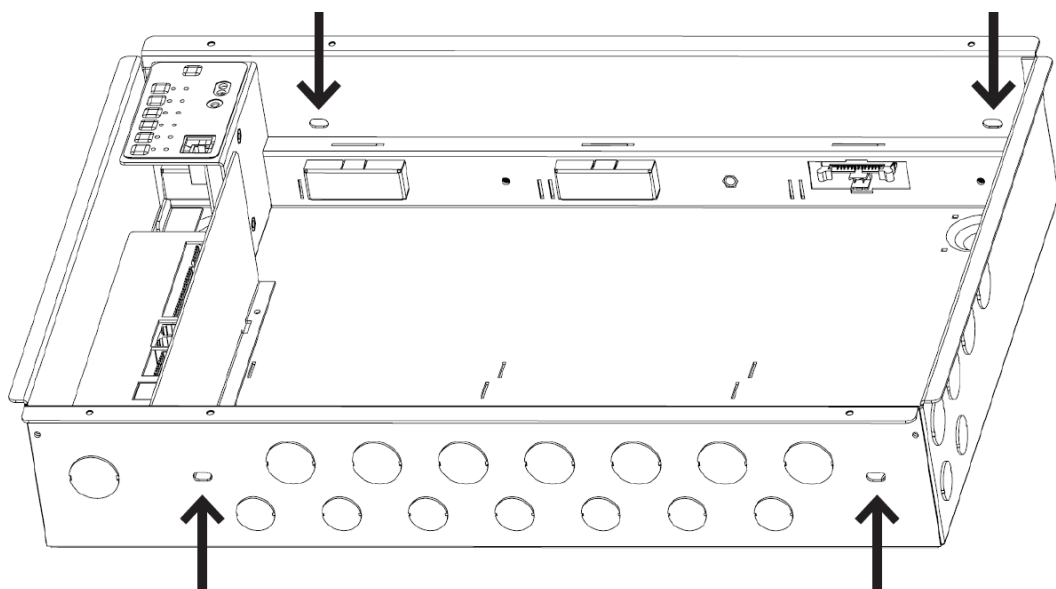

Ensure no dust or other debris enters the device during installation. Do not leave the front cover off for any length of time. Excessive dust may interfere with cooling.

2.5 Inserting and connecting modules

Control modules fit in either mounting bay, and you can install any two modules in the same unit. Control modules are connected to the supply module with the supplied wiring loom, and to the communication bus with the ribbon cable connectors on the left-hand side of the enclosure.

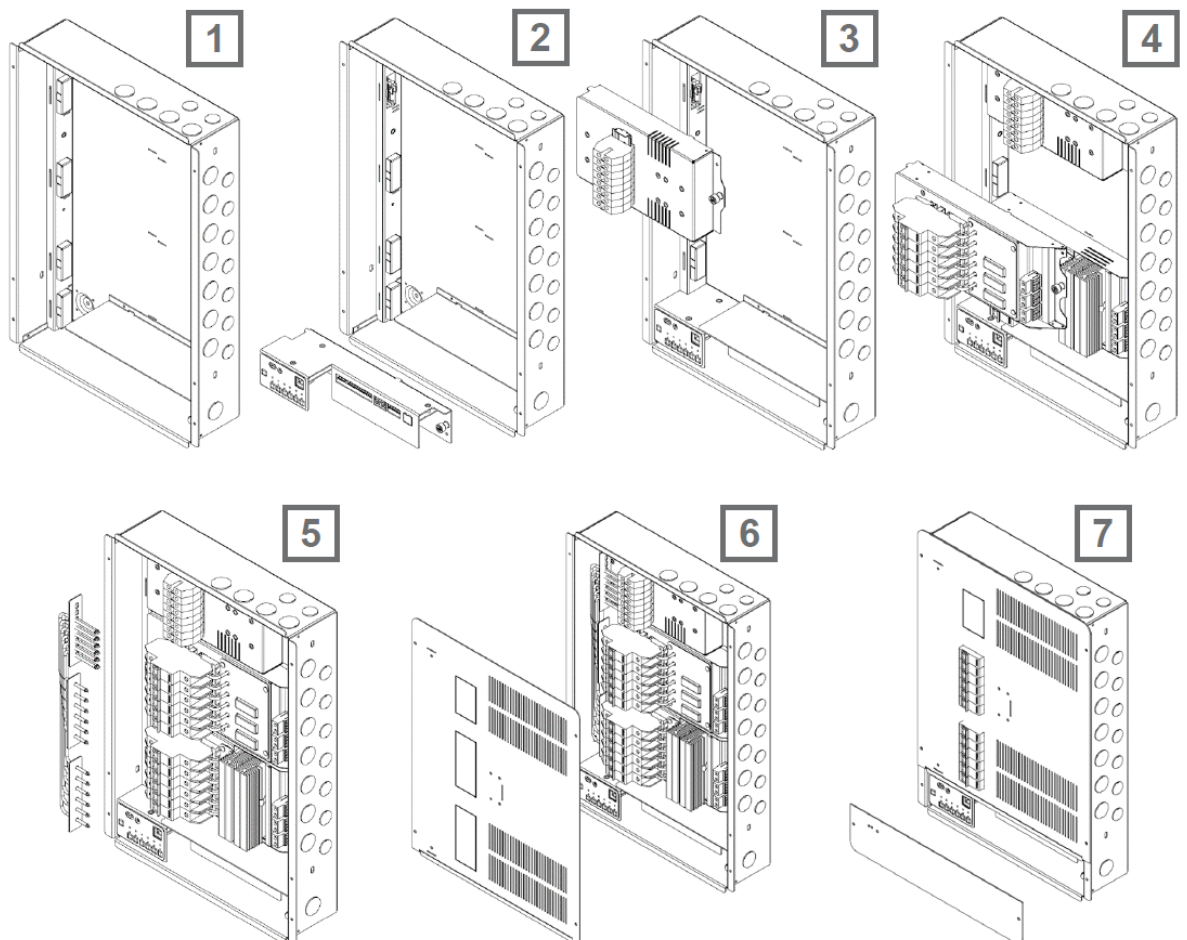

► Install modules:

1. Mount the enclosure using one of the methods described in 2.3 Mounting the DMC2.
2. Mount the communication module below the high-voltage barrier. Refer to the instructions in 2.4.1 DCM-DyNet.
3. Mount the power supply module in the top of the enclosure. Refer to the instructions in 2.4.2 DSM2-XX.
4. Mount the control modules in the remaining module spaces. Any module can be mounted in any location and a location can be left empty. Refer to the instructions in 2.4.3 Control module installation, and the Quick Installation Guide provided with each module.

5. Connect the supplied wiring loom to the modules. Use only the loom supplied with the unit, and do not modify the loom in any way. Refer to 2.4.4 Wiring loom.
6. Check and retighten all terminals. Remove the required knockouts from the top cover plate, then reattach the cover plate to the unit and make sure all screws are tightened securely. Stick the labels provided with modules on the cover to indicate what module is installed in each location.
7. Reattach the bottom cover plate and make sure all screws are tightened securely.

2.5.1 Communication Module - DCM-DyNet

The DCM-DyNet module is mounted in the bottom section of the enclosure, below the high-voltage barrier.

Remove the protective film from the keypad before installing this module.

► Insert the DCM-DyNet:

1. Adjust the jumper located next to the control ribbon cable connector to select the required DyNet voltage: 12V (factory default) or 24V.

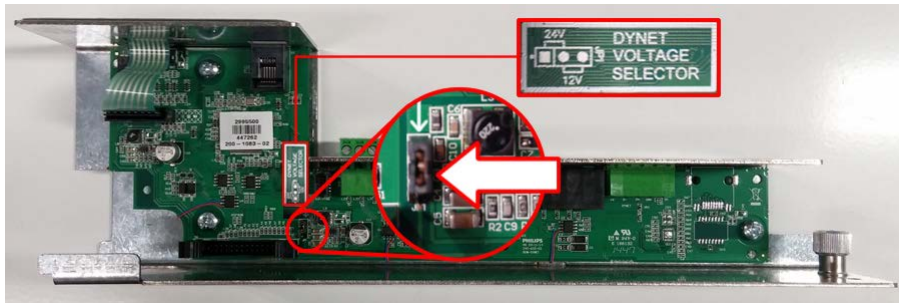

2. Connect the control ribbon cable from the module to the DMC communication bus.

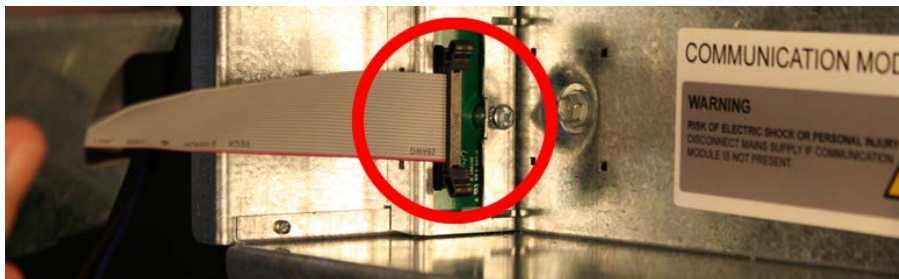

3. Align the mounting tab with the slot on the left and slide the module into position.

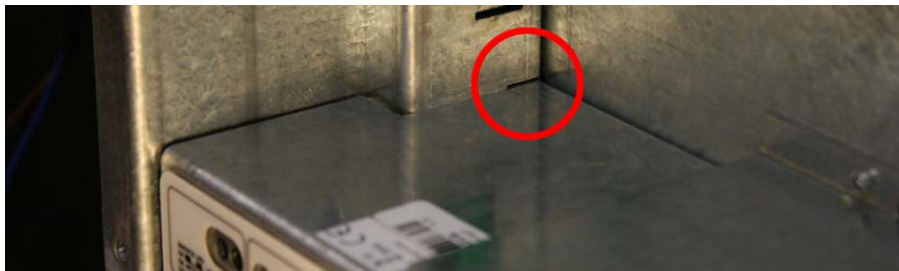

4. Secure the module using the fixing screw on the right. The unit should sit securely with no movement.



The DCM-DyNet installation is now complete.

2.5.2 Supply Module - DSM2-XX

The DSM2-XX module is mounted in the top section of the enclosure.

► Insert the DSM2-XX:

1. Connect the 24VDC Class 2/SELV supply plug to the two-way socket behind the DMC communication bus socket. Note that the internal power supply is derived from phase L1. For correct operation of the unit, ensure that supply on phase L1 is always present.

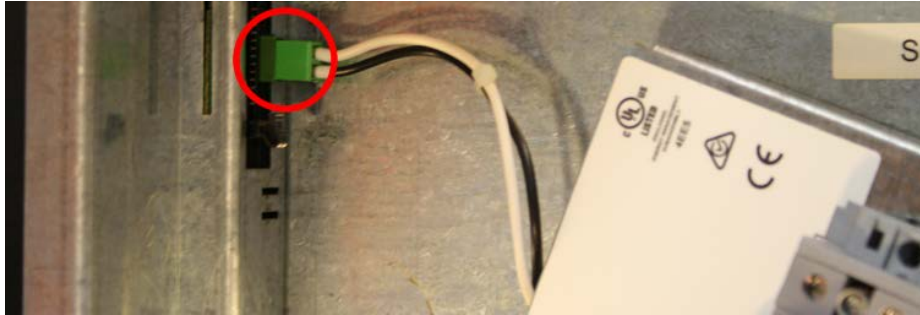

2. Locate the tab and slide the module into position as shown.

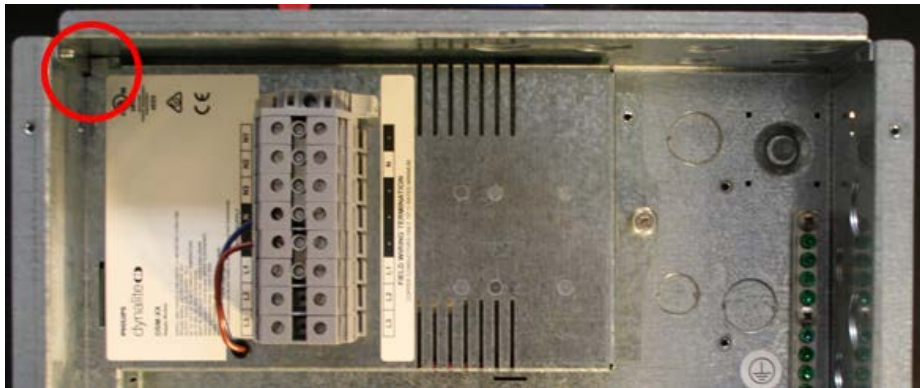

3. Secure the module using the fixing screw on the right. The unit should sit securely with no physical movement.

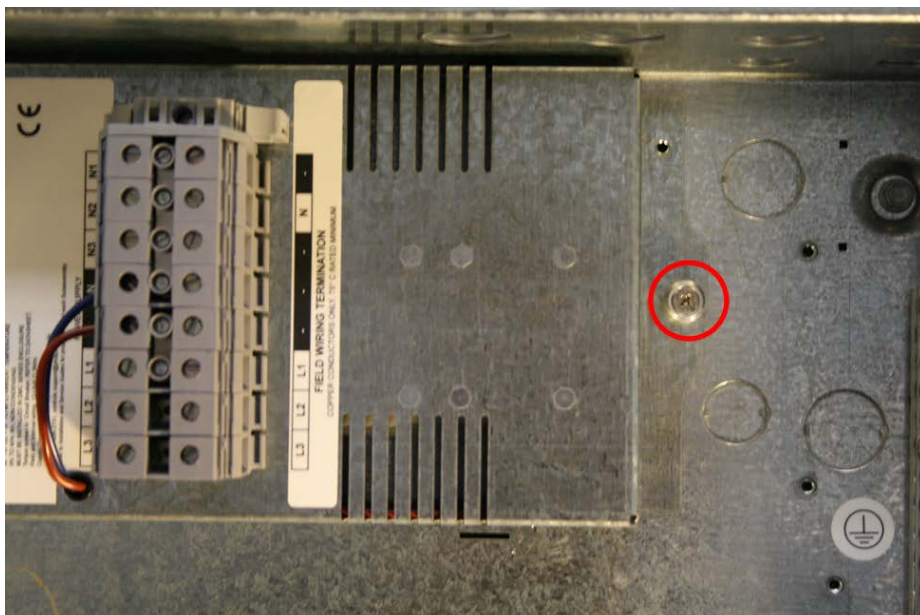

4. Terminate the supply wires into the right-hand side of the terminals and to the Earth bar on the right-hand side of the enclosure.

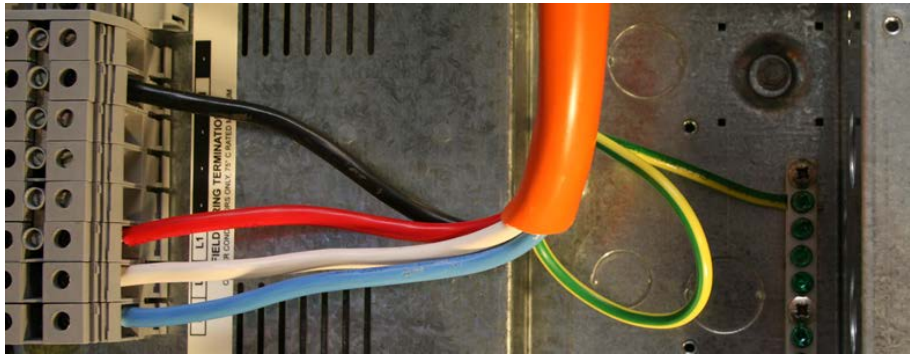

5. Terminate the supply group of the wiring loom into the left-hand side of the terminals. Refer to 2.4.4 Wiring loom for more information.

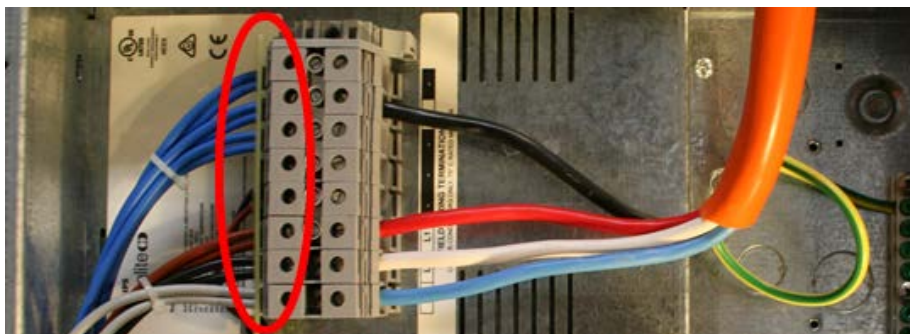

6. Recheck all terminal screws and tighten as needed.



The DSM2-XX installation is now complete.

Note: Phase one power (L1) must be supplied for the DMC to operate. All internal modules receive power from phase L1. If this phase is not supplied, the device will not turn on (even if L2 and L3 are still available).

2.5.3 Control module installation

Control Modules can be mounted in any available module location within the DMC unit.

► Insert the control module:

1. Mount the circuit breakers. Use only the circuit breakers provided in the installation kit, oriented so that they are isolated when switched toward the output side as shown.

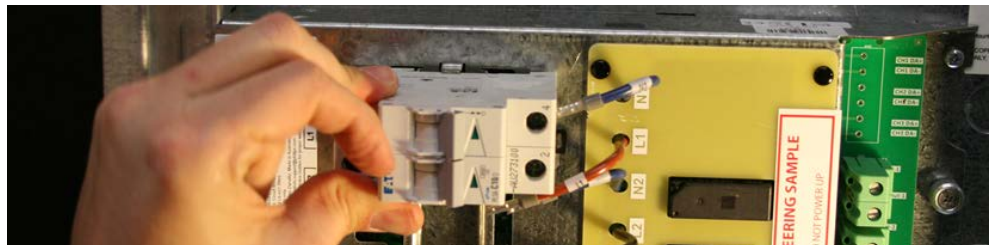

2. Connect the SELV / Class 2 control ribbon cable between the module and the DMC communication bus.

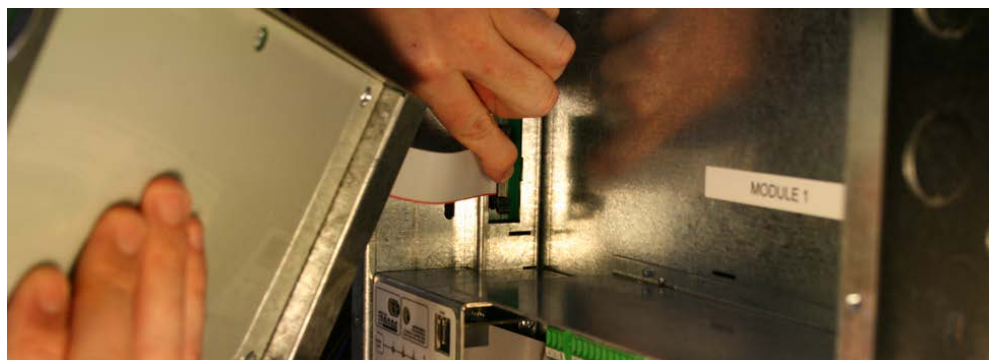

3. Locate the tab and slide the module into position.



4. Secure the module using the fixing screw on the right side. The unit should sit securely with no physical movement.



5. Terminate the control module's supply input wires into the right side of the circuit breakers.

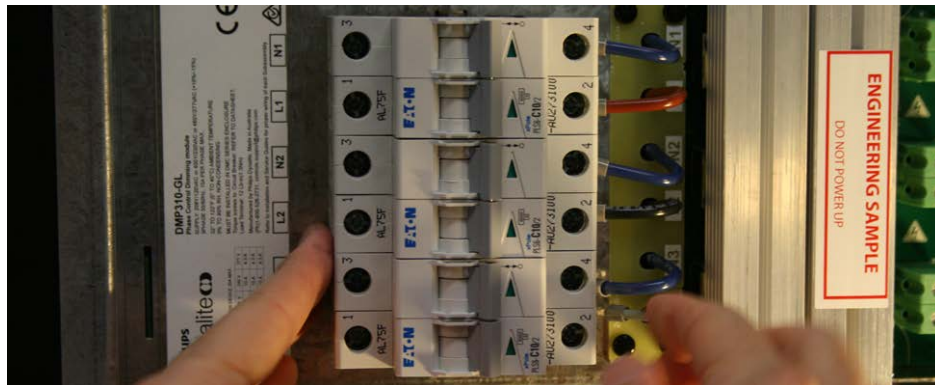

6. Terminate the corresponding Module group of the wiring loom into the left side of the circuit breakers.

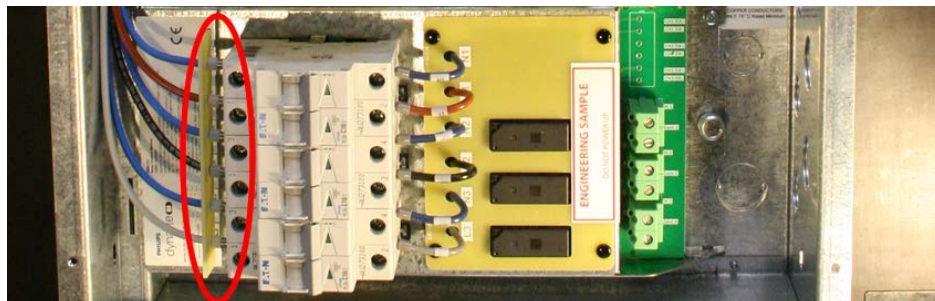

7. Recheck all terminal screws and tighten.

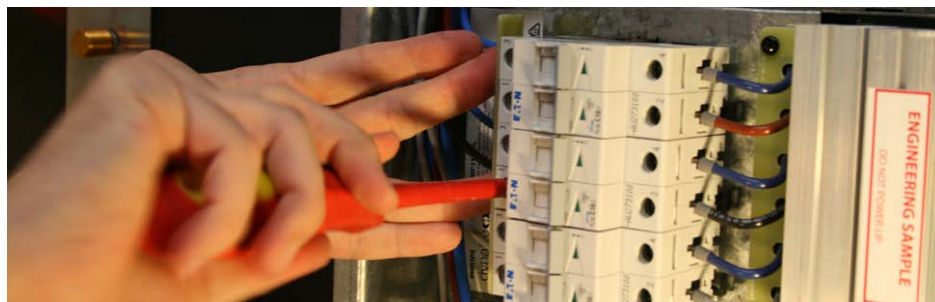

The control module installation is now complete. The lighting/load groups can be terminated into the module's output terminals.

Note: Refer to **1.3.2 DMD31X module output wiring** for further information before terminating DMD31X module loads.

2.5.4 Wiring loom

The DMC wiring loom is designed to ensure correct wiring from the power supply module to the control modules. The terminations for each module are held in the required order with clearly labelled plastic brackets.

Make sure the labels on each bracket correspond to the wiring on each module, as shown here.

For modules requiring termination, remove the black insulating caps from the wires before terminating to the load and supply modules.



Warning: Use only the wiring loom supplied with the unit, and do not break or modify the loom in any way.

Take care to ensure that no wires are caught under the cover when closing the device.

The black insulating caps on the harness are only to be removed when wired to a module. If any are not used, ensure they are securely attached and the connector underneath is not exposed. If the black caps are not available, the unterminated wires must be protected with a mains-rated isolating electrical terminator before the DMC is energized.

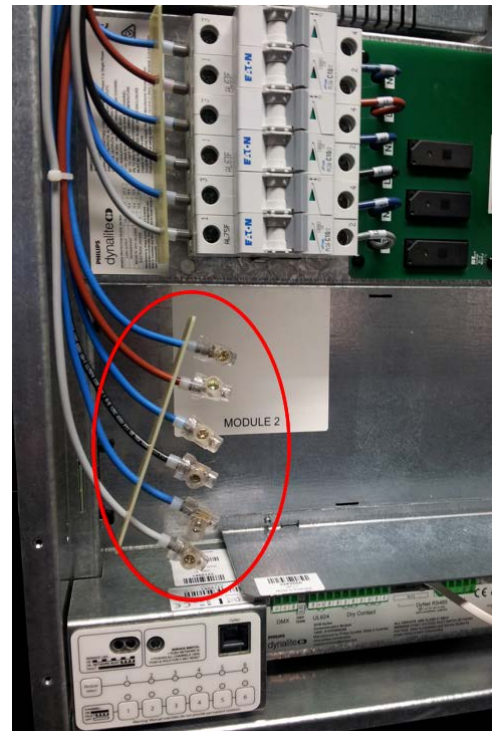
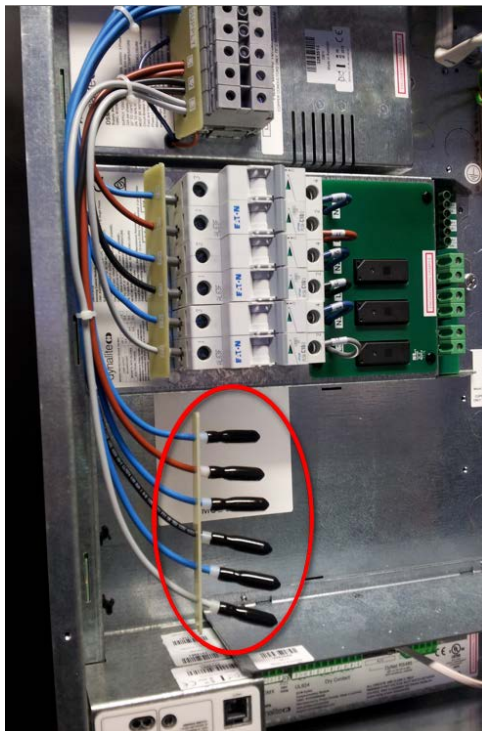

3 Post-installation testing

If you need to energize the load circuits on the DMC before connecting it to the rest of the network, you can replace the cover and energize the device immediately. The default factory programming sets all channels to 100% output.

For more information on testing and troubleshooting procedures, visit <https://dynamlite.org/>

3.1 Service LEDs and switch

The DMC has a green and a red service LED. Only one LED is lit at a time:

- Green: DyNet Watchdog activated and network 'heartbeat' signal detected
- Red: DyNet Watchdog deactivated or timed out (indicates possible network fault)

The 'heartbeat' signal is transmitted periodically over DyNet by other network devices such as gateways, allowing the DMC to easily tell if it is still connected to the rest of the network.

For more information on configuring the DMC's Watchdog settings, refer to the DMC2 Commissioning Guide.

The active service LED shows one of three patterns:

- Blinking slowly: Normal operation
- Blinking quickly: Normal operation, network activity detected
- Permanently ON: Fault

The service switch activates the following functions:

- One press: Transmit network ID
- Two presses: Set all channels to On (100%)
- Press and hold for four seconds, then release: Reset the device

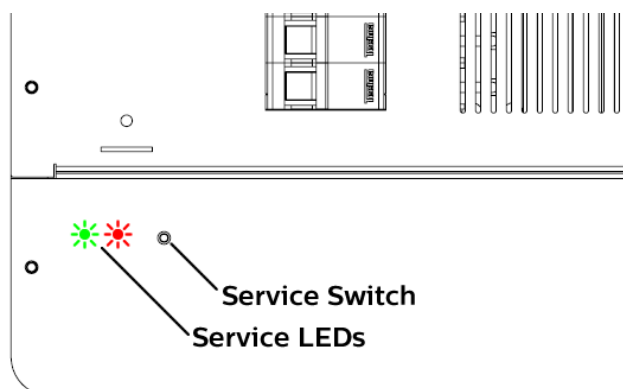

3.2 Manual override keypad

WARNING: Manual overrides do not provide permanent isolation. Isolate at the supply before performing work on load circuits.

Once the DMC2 has been fully installed and energized, you can remove the bottom cover plate and use the keypad on the DCM-DyNet module to test each module and channel in the device.

- Press the Module Select button to select the module for testing. If a module is not detected, the indicator will automatically skip to the next module.
- The CHANNEL light for each channel shows whether the channel is Off/unused (0%) or On (1-100%). Faulty channels are indicated by a flashing light.
- Press the channel number button to toggle the channel between Off (0%) and On (100%).

The keypad times out after 30 seconds. At this point the keypad switches off but all channels remain at their current level.

