

Rako RMT500 Installation, Programming and Operating Instructions

General

Rako RMT500 modules are digital trailing edge dimmers suitable for use with mains voltage tungsten lighting, low voltage tungsten with electronic transformers and mains voltage LED lamps.

RMT500 dimmers are **NOT** suitable for inductive loads such as wire-wound transformers or electric motors.

RMT500 dimmers can be controlled by any Rako device that transmits wireless RAKOM messages.

Before commencing installation of a Rako dimmer please read this instruction manual carefully. Rako Controls Ltd accepts no responsibility for damage or injury caused by incorrect installation of a Rako product.

Installation should only be carried out by a competent electrician.

Never attempt to connect a Rako dimmer or remove the terminal cover without first isolating the circuit at the fuse/MCB board.

The circuit supplying a Rako dimmer should always be protected by either a 5A fuse or 6A MCB.

Mounting

Rako modules should be mounted in areas that are adequately ventilated, dry and outside of any enclosed metal casings that may interfere with the wireless signal. Wherever possible the mounting bracket should be used.

Modules should be mounted vertically, with the terminals at the bottom, or horizontally with the ventilation slots at the top.

Whilst Rako dimmer modules are designed to be completely maintenance free the units should be mounted in an accessible location should there be a fault or re-addressing of the unit be necessary (see 'Set-up and Addressing')

Loadings

Min – 1W/Max – as below

Mains voltage tungsten – 500W

Low voltage transformer loads – de-rate by 10%

Mains voltage LEDs – LED characteristics vary hugely.

As a rule allow a maximum of 10 lamps per dimmer, more may be possible but contact Rako for advice.

Connections

Connect the RMT500 according to the wiring diagram overleaf.

Do not use loop In/Out connections within the module. A junction box should be used if required.

Ensure the cable clamp bar securely clamps the cables and that the terminal cover is fitted before switching the supply on.

Initial Checks

When power is initially connected to the module the unit should switch the load ON. The load can then be manually switched using the clear button on top of the module.

The factory set address for both modules and transmitters is House 1 Room 4 (See Fig 1 for further information). A Rako wireless wallpanel set as address House 1 Room 4 will control and dim the module.

Should the module not respond as above then further investigation should be made before proceeding further.

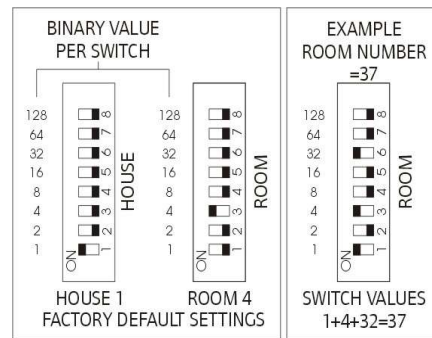

Fig.1

Set-Up and Addressing

RMT500 modules can be programmed manually or by using RASOFT programming software. For software programming refer to the appropriate programming guide supplied as a PDF with the programming interface (RA or RTC-Bridge etc.) or download from our website: www.rakocontrols.com.

Manual Addressing from Wallplate or Handheld

Before any lighting scenes can be programmed (see the wall-panel or hand-held manual) the RMT500 module needs to be addressed.

To avoid interference between neighbouring installations choose a House address other than the factory default of House 1 and set this on the transmitters using the House address switches. Keep the House address the same throughout the project (for master functions).

Choose a Room address for each separate room or area to be controlled independently and set this on the appropriate transmitters using the Room address switches. **Note:** Any control panels set with the same address will act as two or multi-way controls for the same Room.

The module now needs to be sent its new House and Room address from the appropriate keypad. For rooms with multiple modules each module needs to be also assigned a separate Channel number from 1-15 within each Room.

The House and Room addresses are set using the switches on the back of a Rako transmitter (see Fig 1) and the Channel addresses are selected by putting a transmitter in programming mode and 'stepping' through the channel numbers (see Step 3 overleaf). This number is then 'sent' (along with the House and Room address) to a receiver (Step 5).

Notes on address switches

The address numbers are set using the switches on the back of a Rako transmitter. Binary coding is used and a diagrammatic explanation is given in Fig 1. It is not however necessary to understand binary just set the House switches to a different setting than the factory default and use a different combination of Room switch settings for each room or area to be controlled separately.

Notes on Addressing

A dimmer cannot be set to an address of House 0 (All switches set to off)

A dimmer will respond to, but not receive an address of Room 0 (All switches set to off). This Room 0 address is used for 'Master House' control

A dimmer cannot be set to channel 0.

To program a lighting scene see Wall panel or Hand held manual.

Power-Up Mode

With the factory address setting of House 1 an RMT500 will turn ON when power is applied. When the House address is changed the Power-Up mode becomes 'OFF' which is generally preferred, for instance if there is a power cut during a holiday.

Manual Operation

The clear button can be used as a manual On/Off switch.

Multiple Control Panels

If the dimmer module is to be controlled by two wall or hand-held transmitters it is only necessary to address the module to one of these transmitters. Set the other transmitters to the same House and Room address and they will transmit exactly the same message as the first transmitter and the module will respond accordingly.

LED functions

The internal LED behind the clear button will flicker when the module receives ANY Rako wireless message and is a useful diagnostic indicator. This function becomes inactive after 20 minutes to avoid nuisance light spill but can be re-activated by pressing the clear button.

If an RMT500 module has already been addressed to a wall-panel the internal LED will start to pulse as soon as that transmitter (or any other transmitter with the same address) is put into programming mode. The module can still be re-addressed in the normal way, for example when changing its Channel address within the same Room.

Care and Maintenance

A Rako dimmer module contains no user serviceable parts. Should for any reason you need to contact us please contact us via our website www.rakocontrols.com or by phoning our customer help line on 01634 226666.

Initial Addressing of a Rako Receiver Module

In the following procedure both the controllers (wallpanels and hand held remotes) and the receivers have an automatic time out after approximately 3 minutes when in programming or set-up mode. This feature avoids the possibility of either being left permanently in programming or set-up mode. This may cause confusion if either the controller or receiver times out before the procedure is complete. It is worth becoming familiar with the procedures before starting the addressing procedure. If at any time it is necessary to start again the controllers can be returned to normal mode by pressing the 'Off' button and the receivers by resetting the electrical supply.

Step 1
Set address switches on controller

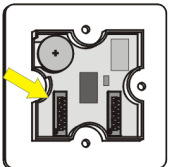

Pick a House address from 1-255 (keep same address for all panels in house)
Select Room addresses from 1-255 for each room (Room 0 is master house control)

Step 2
Put controller into programming mode by pressing and holding a scene button and both raise and lower buttons together. After 5 seconds the LED on the panel starts to flash. The panel is now in programming mode. Release the buttons

TIP
Press the scene button first

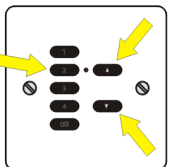

TABLE 1

Button	Action
1	Step up one channel and ident
2	Step down one channel and ident
3	Ident
4	No action
Off	Exit programming

Note:
A Rako panel will always enter programming mode at Channel 0. It is not possible to give a receiver an address of Channel 0 but this gives a consistent starting point.

Note:
When in programming mode the buttons have functions as detailed in table 1.

Step 3
Press button 1 once to step up one channel. If this is the desired channel i.e. Channel 1 (for the 1st receiver) then go to Step 4. If not, press button 1 again to step up to channel 2 (for the 2nd receiver), again to step to channel 3 etc, until the desired channel number is reached (maximum = 15). It is this channel number (along with the House and Room address) that is sent to the receiver in Step 5. If at any point it is necessary to step down a channel, press button 2 once.

Go to the receiver to be addressed

Step 4



Press the set-up button until the internal LED illuminates and keep the button pressed with the LED on until it starts to flash. Release the button. The module is now in set-up mode.

Note:
If a receiver is already addressed to a controller (for example a receiver is addressed to the controller but with the wrong channel number) then the internal LED will be flashing as soon as the panel is put into programming mode. It will still be possible to re-address this receiver as normal.

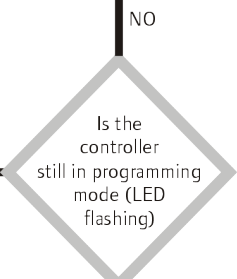
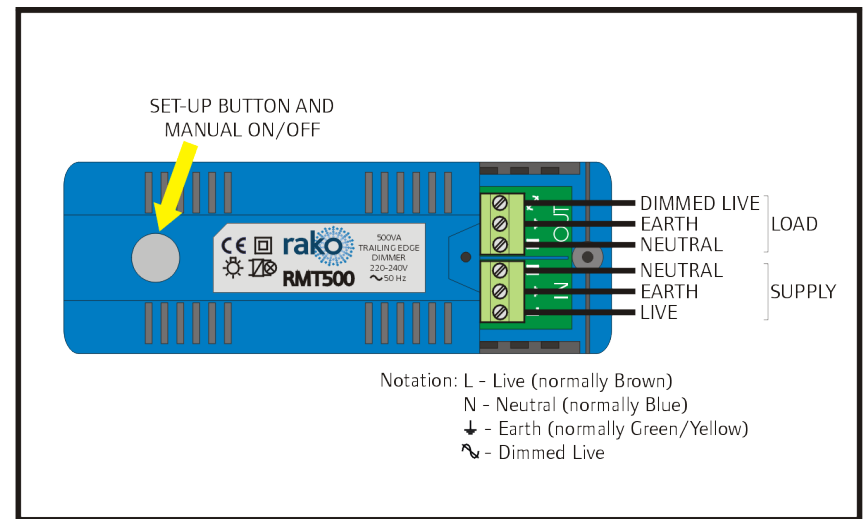

If some receivers are already addressed to the wall panel then they will 'flash' their connected lamps as their channel number is reached during the stepping procedure, this allows the user to 'identify' which channel numbers are already taken. To add a new receiver to an existing installation step up through the channels until a channel number is reached where no receiver flashes a load, this is then an available channel. If at any point there is uncertainty as to whether a receiver actually flashed its load then button 3 will flash the load but without stepping up or down a channel. If all of the loads flash then this indicates that the current address is Channel 0.

Note: If it is not possible to see the connected lamps flashing when stepping through the channels it is possible to tell from the LEDs in the receivers which will momentarily go solid when their channel address is reached.

YES

NO

Is there another receiver in the room to be addressed

Step 5
Press button 3 to send the ident of the channel selected in step 3. Receiver automatically returns to normal mode (blue LED goes out) while controller remains in programming mode (red LED keeps flashing)

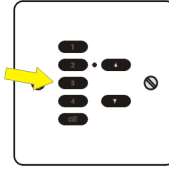

Step 6
Press Off button to exit controller from programming mode

