

**DNG100BT  
DDNG100BT  
DMNG100BT**

**Programming & Application Manual**



**DNG100BT**



**DDNG100BT**



**DMNG100BT**

**Contents**

Configuring the DNG100BT ..... 2

- . Ethernet Gateway mode ..... 2
- . A Dynamalite network for a large campus ..... 3
- . An Intranet Web interface to the Dynamalite network ..... 4
- . Interfacing to a third party control system ..... 4
- . Monitoring a remote site ..... 5
- . PC Software ..... 6
- . Dlight2 configuration dialog ..... 6
- . CGI Interface ..... 9
- . Retrieving Status From DyNet Areas ..... 10

DNG100BT COM Port Redirection Mode ..... 12

Wireless Connectivity ..... 15

- . Setting up the wireless router ..... 16

Setup Instructions for DNG100BT with DLight III 3.3 ..... 17

- . Installing Dlight III 3.3 ..... 17
- . Setup of the DNG100BT in DLight III 3.3 ..... 17
- . Miscellaneous ..... 21

# Configuring the DNG100BT

## Ethernet Gateway mode

The DNG100BT provides an Ethernet interface to a Dynalite network. 5 gateway modes are available:

1. **Passive TCP** – In this mode the local DNG awaits a TCP connection made by a remote DNG or PC application. DyNet Packets are transported using TCP Packets. This option is good for point-to-point networks over the internet.
2. **Active TCP** – In this mode the local DNG initiates and maintains a TCP connection to a remote DNG. DyNet Packets are transported using TCP Packets.
3. **UDP** – In this mode the local DNG relays DyNet messages to multiple other DNG's. DyNet Packets are transported using Broadcast UDP Packets. This option is good for multi-device networks within intranets.
4. **HTML** – In this mode the DNG hosts basic WebPages that can be used to send commands to and show status of the Dynalite network. A CGI interface provides the dynamic content for those pages. This option is good for providing a customized user interface to the Dynalite network.
5. **Telnet** - In this mode the local DNG awaits a TCP connection made by a remote Ethernet enabled device or PC application. The DyNet Text protocol can be used to send commands to and retrieve status from the Dynalite network. This option is good for integration to third party devices that are Ethernet enabled.

More information can be found in the "DyNet Integrators hand book for the DNG100BT"

## Protocols Used

The table below details functionality on each of the IP transport layers:

Mode	TCP	UDP	HTML	Telnet
Application			HTML, JavaScript, Flash	Telnet
Presentation			CGI	DyNet Text Protocol
Session	DyNet	DyNet	HTTP	TCP
Transport Network	TCP	UDP	TCP	
Data Link	IP, ARP, DHCP, AutoIP			
Physical	Ethernet			

Fig 1.1

## Sample Applications

Sample applications are included here as a guide to what could be achieved using this product.

## A Dynalite network for a large campus

Where segments of a Dynalite network are separated by great distances, or where there are cabling route difficulties, An existing Ethernet network may be used to carry DyNet.

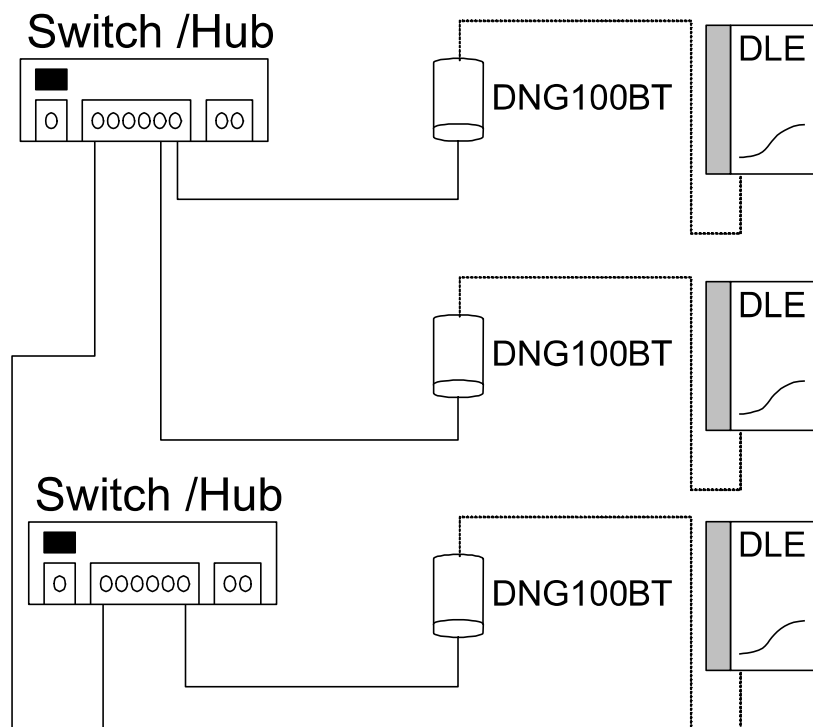

Fig 1.2

Each DNG100BT should be set to UDP mode.

The Local and Remote Port number should be set to the same number from the unreserved range of port numbers greater than 1024, in each DNG100BT.

The Remote

IP address should be set to an appropriate broadcast address for the domain. This address specifies the destination address for Dynet Commands received by the DNG100BT.

For example:

In a domain where the subnet mask is **255.255.255.0** (the default mask for Class C IP Address) and the devices Local IP address is **192.168.10.100** The Remote address should be set to **192.168.10.255**.

Issues to consider

- If network configurable devices such as bridges or gateways are present between the DNG100BTs then, they must be configured to pass the multicast UDP traffic.
- The DNG100BT has no DyNet bridging functions DyNet addresses may not coincide on network segments.
- No direct DyNet connection may be made between network segments as this would introduce a looped network topology with unpredictable results.

## An Intranet Web interface to the Dynalite network

Where multiple local workstations occasionally need to access lighting controls as in Fig 1.3.

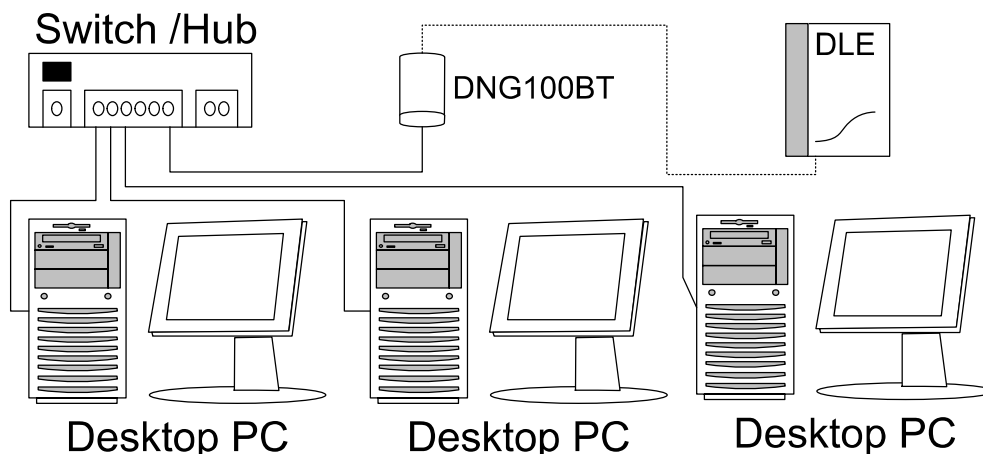

Fig 1.3

Complete the following steps:

1. Set the DNG100BT to HTML mode.
2. Don't use the remote port and IP address fields in this mode.
3. See the CGI Interface section for this document for information on details on web content development.

Issues to consider:

- Individual Files must not be greater than 64K.
- The total storage of a DNG100BT (V3) is 1MB.
- If the requirements for the application are larger than 1MB, then the content should be served from the Intranet web server with CGI calls directed to the DNG100BT.
- The default page should be named **Index.html**.
- The filename **SetDyNet.cgi** is reserved for issuing DyNet commands.
- The filename **GetDyNet.cgi** is reserved for retrieving DyNet status.

## Interfacing to a third party control system

Where an Ethernet enabled third party control system is required to send commands to, or receive events from a Dynalite network, the DNG100BT can provide this interface.

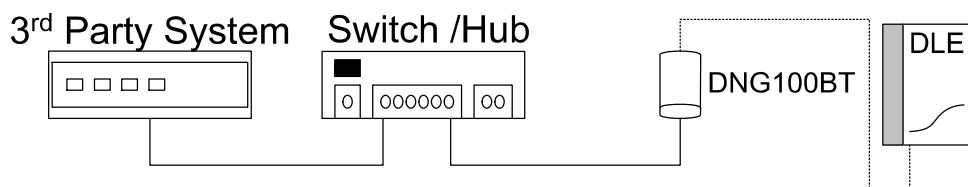

Fig 1.4

To achieve this, complete the following:

1. Set the DNG100BT to Telnet mode.
2. Set the Local port (this is usually set to 23 but can be set to any port number).
3. Don't use the remote port and IP address fields in this mode.

The DNG100BT will wait for an incoming connection and present the DyNet text Interface. Information on the command protocol can be found in the DyNet Integrators handbook for the DNG100BT.

Issues to consider:

- No security is provided by the DNG100BT, anyone who connects to this port will be granted full control of the Dynalite network.
- When Telnet mode is active all other modes will be suspended while the connection is active.

## Monitoring a remote site

Where remote workstations occasionally need to access a local Dynalite lighting control system.

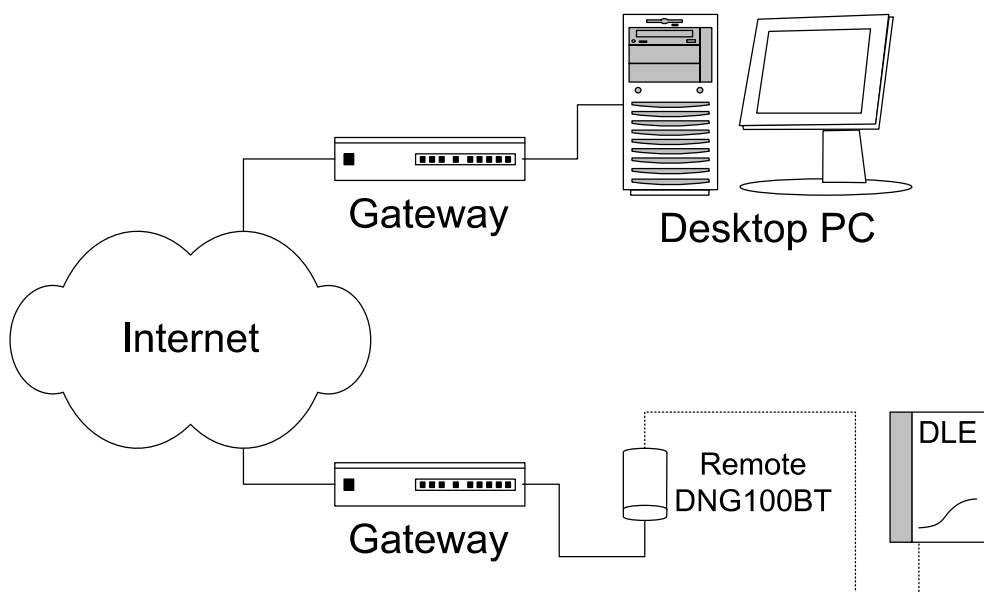

Fig 1.5

Complete the following:

1. The DNG100BT should be set to Passive TCP.
2. The local port should be set to a number from the unreserved range of port numbers greater than 1024. This is the port on which data will be transmitted from the DNG100BT.
3. The remote port should be set to a number from the unreserved range of port numbers greater than 1024. This is the port on which data will be received by the DNG100BT.
4. The IP address field is not used in this mode.

Issues to consider:

- No security is provided by the DNG100BT, anyone who connects to this port will be granted full control of the Dynalite network.
- Virtual Private Networking could be used to secure this interface.
- Currently the Dynalite software packages can not communicate directly with the DNG100BT. A serial port redirector is required to redirect communications from a local serial port to a remote TCP port.

## PC Software

Lantronix **Device Installer Version 3.6** or later can be used to install custom web pages and upgrade the firmware of the DNG100BT. This software package may be downloaded from the Lantronix website.

- <http://www.lantronix.com/device-networking/utilities-tools>

Dlight build 860 or later is required to configure the settings of the DNG100BT.

This dialogue is displayed from the **Utils > Edit Ethernet Data** menu, it contains all the settings relevant to the DNG100BT. Also Port 2 of the DNG100BT should be set to text gateway in the Serial port settings dialogue.

# Configuring with Envision Project

The DNG100BT/DDNG100BT/DMNG100BT product range is Philips Dynalite's Ethernet gateway, it can be utilised as a network bridge or to facilitate wireless connection to a Philips Dynalite network.

For Bridge configuration see section on Bridge Wizards.

## Wireless DyNet Network Connection

To configure a 100BT device for wireless Dynet connection, follow the steps below:

1. In the **Network** view click on the Network Gateway you wish to configure.
2. Click the Ethernet Gateway tab.
4. Choose if you want to use a static IP address.

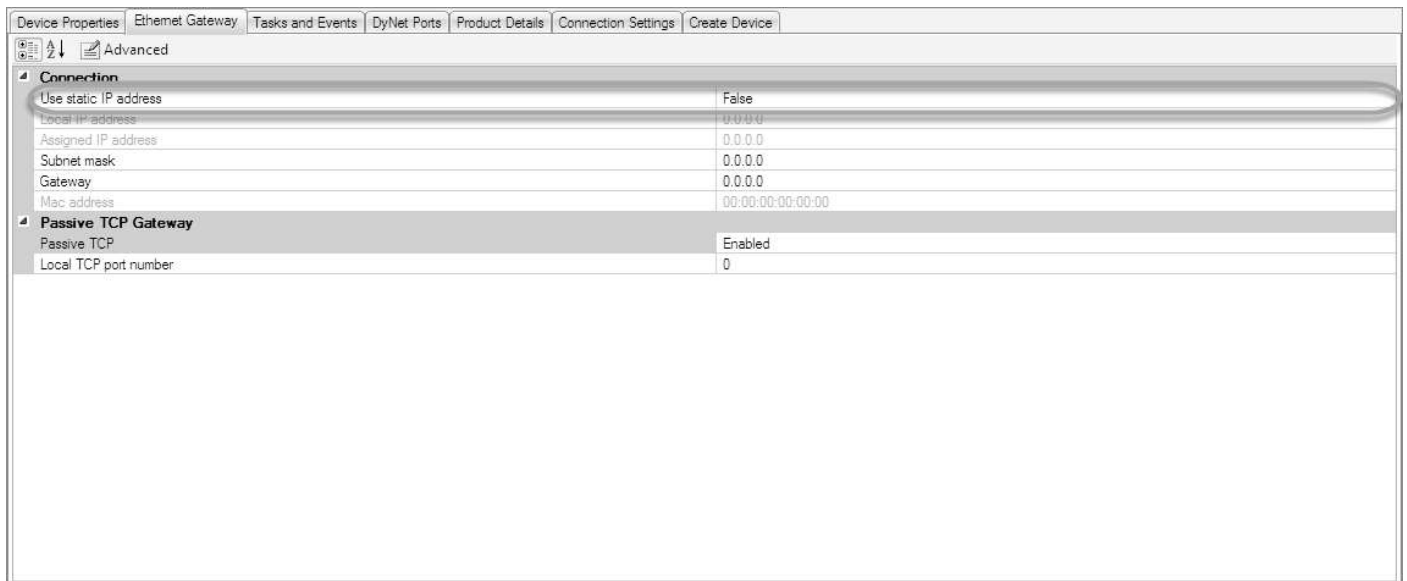

### ***Ethernet Gateway tab***

#### Static IP Addressing

- Select **False** from the drop down list.

#### Manual IP Addressing

- Select **True** from the drop down list.
- Enter a logical IP Address - Required.
- Enter a Subnet mask - Optional.
- Enter a Gateway - Optional.

5. Change the **Passive TCP** field to **Enabled**.

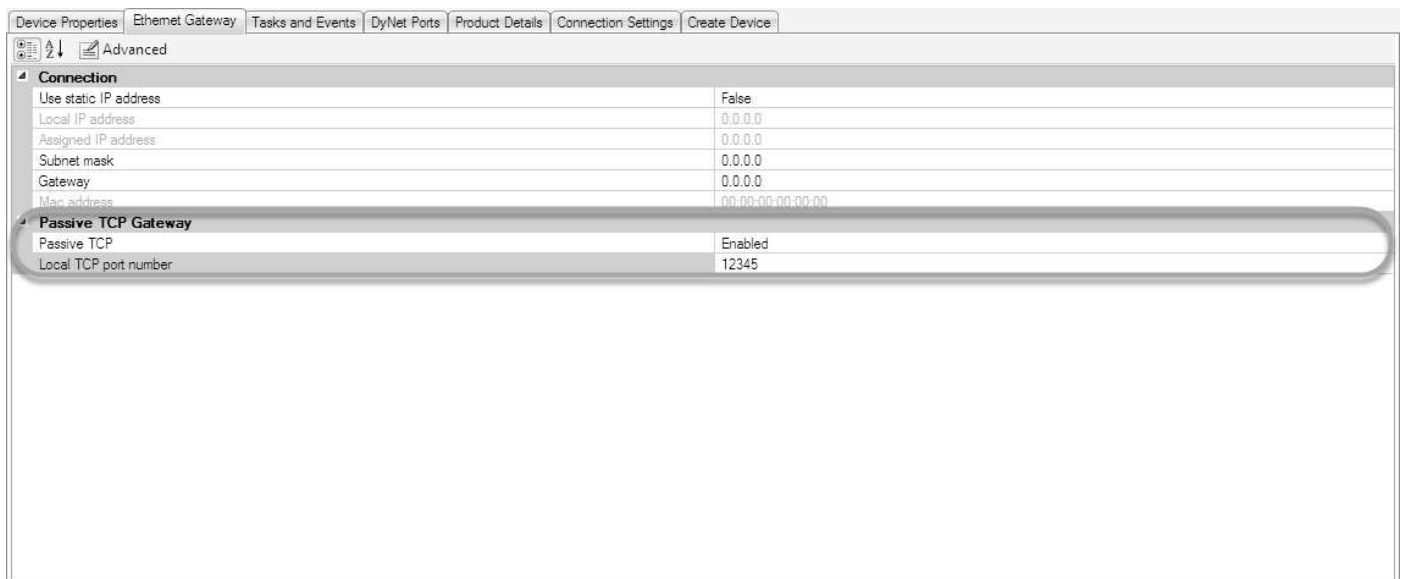

**Ethernet Gateway tab**

5. Enter **12345** into **Local TCP port number** field.



6. Click  in the Network View to save the settings to the network gateway.

Please refer to the Envision Project training guide book for more information for configuration.



## CGI Interface

This section describes the common gateway interface that is available in HTML mode.

### Controlling DyNet Areas.

DyNet logical commands are issued using the HTTP Get method on the SetDyNet.cgi File.

```
http:\\192.168.10.10\\SetDyNet.cgi?a=3&p=2
```

Fig 1.8

The response from this HTTP request automatically redirects the browser back to the calling page as detailed below.

```
<html><body onload=history.back()></body></html>
```

Fig 1.9

### Supported Parameters

- **A** - sets the logical area number for subsequent commands, the default value is 1.
- **C** - sets the channel number, the default value is 255 (All Channels).
- **F** - sets the fade time in milliseconds for subsequent commands, the default value is 2000 (2 Seconds).
- **J** - sets the join mask for subsequent commands, the default value is 255.
- **L** - sets the channel level in percent and issues the channel level command (Values 0-100).
- **P** - Sets the preset number and issues the preset command (Values 1-96).
- **S** - Saves the current channel levels to the preset specified (Values 1-96).

Multiple parameters may be used in the one request however only one of them should be of the command type and all parameters are lower case. A preset value of 0 can be used to recall or save the currently selected preset.

## Retrieving Status From DyNet Areas.

DyNet logical status requests are Issued using the HTTP Get method on the GetDyNet.cgi File.

```
http:\\192.168.10.10\\GetDyNet.cgi?a=2
```

Fig 2.0

The response from this HTTP request contains the state retrieved from the DyNet area. A single numeric value is returned indicating the current preset or channel level. If the logical entity does not exist a single full stop character "." is returned.

If the response shown below is returned from the request shown above then area 2 is currently in Preset 4.

```
p=4
```

Fig 2.1

### Supported Parameters

- **a=** sets the logical area number and requests the current preset for this area.
- **c=** sets the channel number and requests the target level for this channel.

If both c= and a= are specified then only the channel level request is issued.

### Return Values

- **p=** indicates the current preset for the requested area.
- **l=** indicates the target channel level.

### Sample Javascript

This sample script can be used to retrieve the status of a DyNet area.

Other options for client side code Include Flash and Activex.

A HttpRequest object is used to make synchronous http requests of the DNG100BT. For Microsoft browsers use Msxml2.XMLHTTP or Microsoft.XMLHTTP for mozilla browsers use XMLHttpRequest.

**Note:** When a synchronous request is made, browser execution is suspended until the DNG100BT responds, for this reason you may consider using the asynchronous mode.

```

</script>
<script type="text/javascript">

function getHTTPObject()
{
    var xmlhttp;
    /*@cc_on
    @if (@_jscript_version >= 5)
        try {
            xmlhttp = new ActiveXObject("Msxml2.XMLHTTP");
        } catch (e) {
            try {
                xmlhttp = new ActiveXObject("Microsoft.XMLHTTP");
            } catch (E) {
                xmlhttp = false;
            }
        }
    @else
    xmlhttp = false;
    @end */
    if (!xmlhttp && typeof XMLHttpRequest != 'undefined') {
        try {
            xmlhttp = new XMLHttpRequest();
        } catch (e) {
            xmlhttp = false;
        }
    }
    return xmlhttp;
}
function GetDyNet(params)
{
var xmlDoc = getHTTPObject();
    xmlDoc.open("GET", "GetDyNet.cgi?" + params, false)
    xmlDoc.send();
    var retval = xmlDoc.responseText.split('=');
    return(retval[1])
}

function ShowCurrentPreset()
{
    var ThePreset = GetDyNet("a=1");
    if (ThePreset == 1)
        document.all["Image2"].src = "s1.jpg";
    if (ThePreset == 2)
        document.all["Image3"].src = "s2.jpg";
    if (ThePreset == 3)
        document.all["Image4"].src = "s3.jpg";
    if (ThePreset == 4)
        document.all["Image5"].src = "s4.jpg";
}

</script>

```

Fig 2.2

# DNG100BT COM Port Redirection Mode

## Setting up the Lantronics comm port redirector

This document describes setting up a DNG100BT and a laptop to connect DLight to a DyNet network via Ethernet.

Install Lantronics comm port redirector from the Lantronics website at:

- <http://www.lantronix.com/device-networking/utilities-tools/com-port-redirector.html>

## Creating a DLight batch file

Open a text editor such as Notepad and type in the following:

```
call opencpr [MAC address of 100BT] [Serial port number] [TCP port number]

DLIGHT2 [special ini file]
Closecpr
echo all done
```

File should look like the following:

```
call opencpr 00-20-4A-82-45-18 8 12345
DLIGHT2 wireless.ini
closecpr
echo all done
```

- Save the file as **DlightOverWiFi.bat** and save it to the **C:\Program Files\Dynalite\DLight2** directory.
  - Run the **DlightOverWiFi** batch file, which will then make the connection to the wifi, open dlight and use a special ini file that will set up DLight as required.
1. Set up the DNG100BT. Note that the IP address you will use may be different for your network.

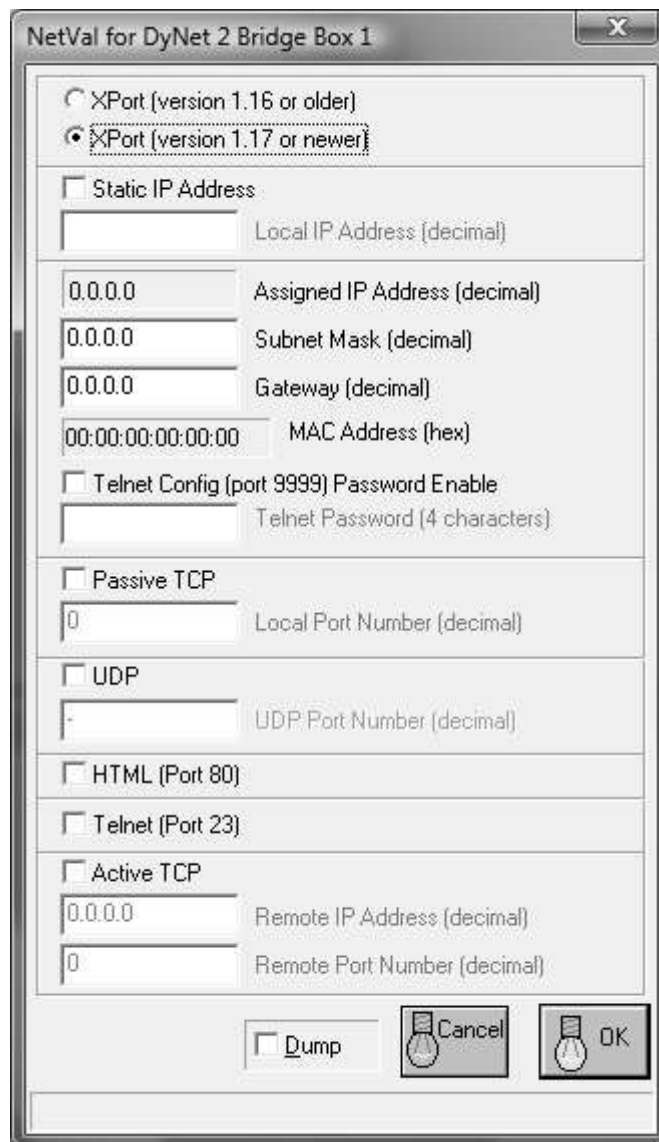

Fig 3.0

2. Install the Lantronics COM Port redirector software: Lantronix Com port redirector 4.0.0.1.
3. Run the Lantronics config program CprMgrCmd.exe usually located in the **C:\Program Files\Lantronix\CPR\ folder**. Pick an unused COM Port number that is not in use by other devices such as RS232 COM ports, PC Nodes or modems. In the following example COM 8 is chosen. At the cprmrcmd.exe prompt type (where [enter] is the Enter key on the keyboard):

```
addport 8 [enter]
addservice 8 192.168.10.227 12345 [enter]
```

Check that the device has been created correctly in Device Manager:

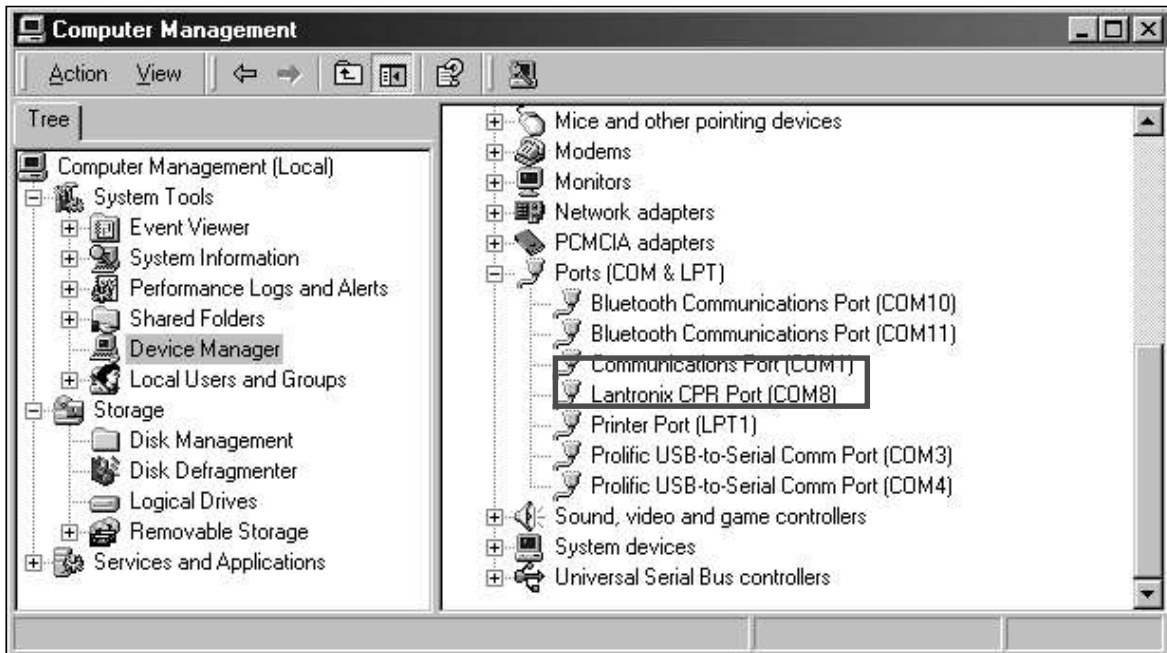

Fig 3.1

4. Set DLight to the correct COM Port.

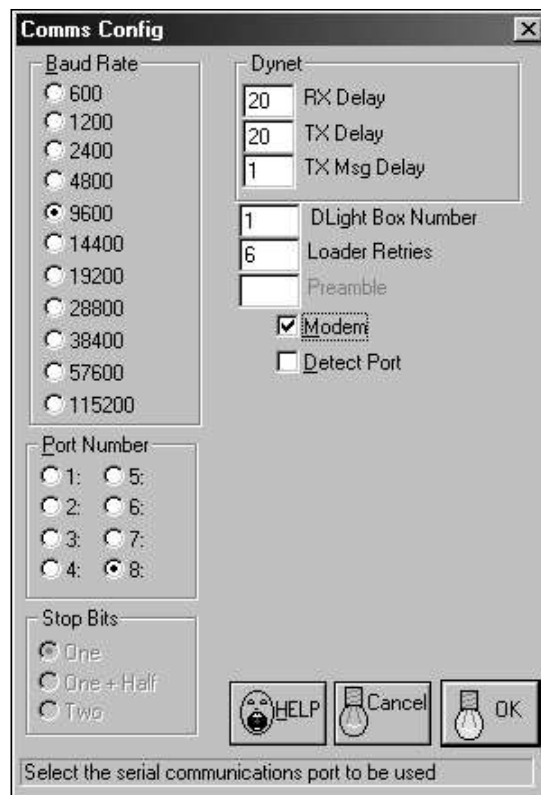

Fig 3.2

## Application

While a hard-wired connection via a PC node is the most straightforward way of connecting a laptop computer to the Dynalite network during commissioning it is not always the most ideal solution. Using the DNG100BT it is now possible to make this connection wirelessly removing the need for a local connection socket and long runs of cable when commissioning.

## Configuration

To configure the DNG100BT, first connect it to the Dynalite network to power the device. Once it is connected, open DLight and load the device. The DNG100BT is part of the D2 Bridge family of products.

Configure the settings page for the DNG100BT as shown below using 12345 as the local port number and selecting Passive TCP as the gateway type.

We have chosen 12345 as the port number as this number must represent a port address that is not already in use and ports up to 1024 are reserved.

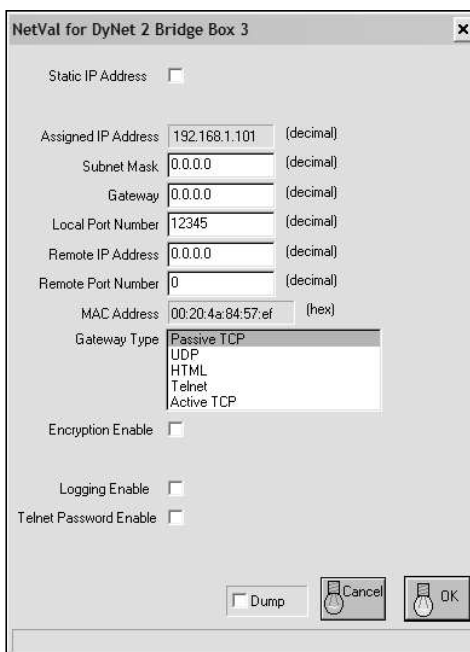

Fig 2.3

## Setting up the wireless router

The process to configure the wireless router will vary for each different manufacturer but the basic procedure should be the same.

Physically connect your laptop to the router.

Type the IP address e.g. <http://192.168.1.1> into Internet explorer to open the configuration page for the router. The gateway IP address is normally the address of the configuration page for the wireless router.



Log into the router using the administrative password and then navigate through the menus to find the list of DHCP clients on the wireless router.



This option is usually found under a status menu.

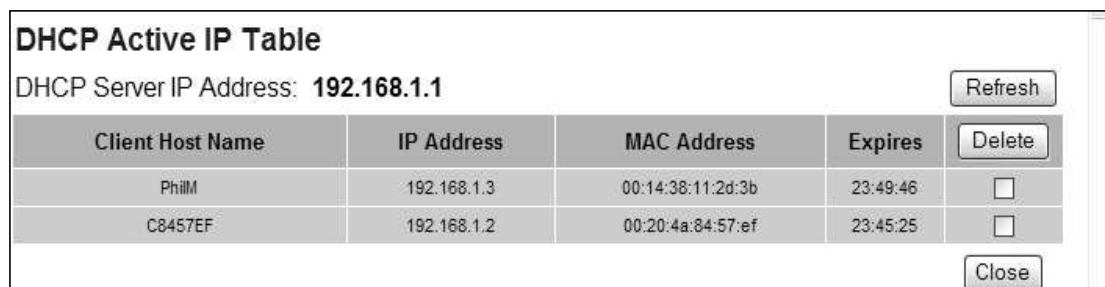

DHCP Active IP Table				
DHCP Server IP Address: <b>192.168.1.1</b>				Refresh
Client Host Name	IP Address	MAC Address	Expires	Delete
PhilM	192.168.1.3	00:14:38:11:2d:3b	23:49:46	<input type="checkbox"/>
C8457EF	192.168.1.2	00:20:4a:84:57:ef	23:45:25	<input type="checkbox"/>

Close

Fig 2.4

Identify the DNG100BT from the DHCP IP table. For DNG100BT with firmware version 3.0 or later, the client host name displayed will be the device name as configured in DLight2. Older versions of firmware will use a random name beginning with C8 (as in the example above).

The MAC address for the 100BT is the address that will be used to make the connection from the comm port redirector. It should be noted down at this point.

Next configure the wireless network properties of the router. Configure a unique SSID and define security settings if appropriate.

Disconnect the physical connection between the router and the laptop and then connect to the wireless network.



# Setup Instructions for DNG100BT with DLight III 3.3

## Installing Dlight III 3.3

The current installer version of this is 3.03.0010.

This version of Dlight III (MapView/Server 3.3 line) is installed in two parts:

1. **Dlight III Installer 3.03.0010 (Server).zip** – installs the DLIII Server components:
  - a. Dlight III server.
  - b. Dlight III server database cache (SQL Express database by default).
2. **Dlight III Installer 3.03.0010 (Client).zip** – installs the DLIII client components:
  - a. MapView program.
  - b. TrayPan program.

Notes:

- The Dlight III 3.3 will no longer contain the merge modules for Microsoft .NET. You should download and install Microsoft's .NET version 2.0 via the Microsoft Website before installing Dlight III 3.3.
- Installing Dlight III 3.03.0010, will not upgrade or replace an existing Dlight III 3.2 or earlier installation, however DCOM registration rules mean that only one Dlight III server will be running at the one time. Installing Dlight III 3.3 will set the new DLightIIIServer.exe version 3.3 build 10 as the current Dlight III server.
- Dlight III 3.3 cache uses a Microsoft SQL database and is completely separate from the old Dlight III 3.2 physical cache file. Customers need to contact Dynalite Distributor Support if they need to migrate server data from Dlight III 3.2 to DLight III 3.3.
- The new default install directory for both the Server and Client components installers is:  
**C:\Program Files\Dynalite\DLight III 3.3.**
- Typically the **DLight III Installer 3.03.0010 (Server).zip** should be installed before **DLight III Installer 3.03.0010 (Client).zip**.

For demonstration purposes, with MapView and DLIII Server installed on the same machine, selecting the default values for installer dialogs should be sufficient.

## Setup of the DNG100BT in DLight III 3.3

The DNG100BT firmware that has been release (v1.08) is not compatible with the 'Device Discovery' implementation in the current DLight III version.

Therefore you will need to configure the list of DNG100BT devices manually. To do this you will need to set up a **DNGManualConf.txt** file to be placed in the same directory as the **DLightIIIServer.exe** program file.

The configuration format in this file is:

- IPAddress:box number:port number

For example:

- 192.168.10.138:69:24601
- 192.168.10.131:18:24601
- 192.168.10.52:16:24601

After installing DLightIII 3.3 build 10, you should follow the following procedure:

- Stop MapView/Server.
- Create the **DNGManualConf.txt** file in the **C:\Program Files\Dynalite\DLight III 3.3** directory as described above.
- Start DLIII Server.
- Launch Config Server.
- Change **Network1** to use **Ethernet24601**.

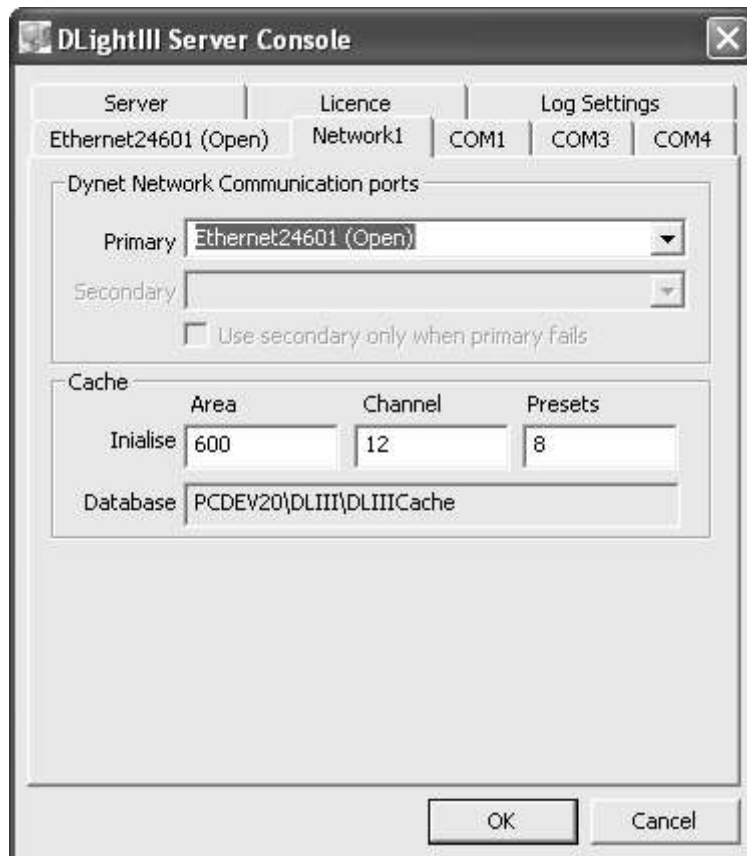

Fig 2.5

- On **Ethernet24601** tab, click the **DNG100BT** button.

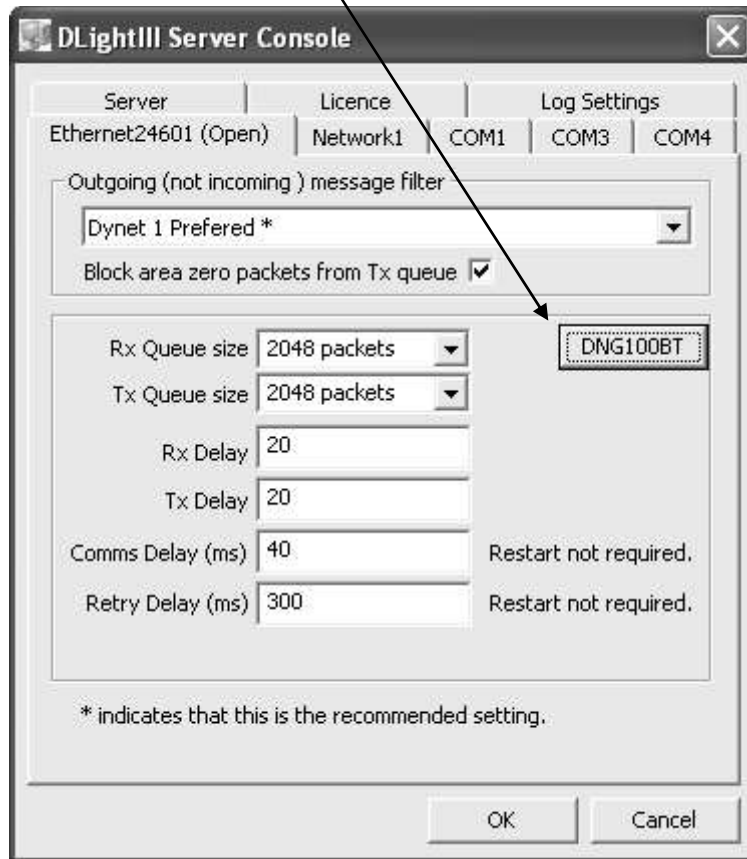

Fig 2.6

- For selected all items in the **Found DNG100BT Devices'** list, and click **Add**.

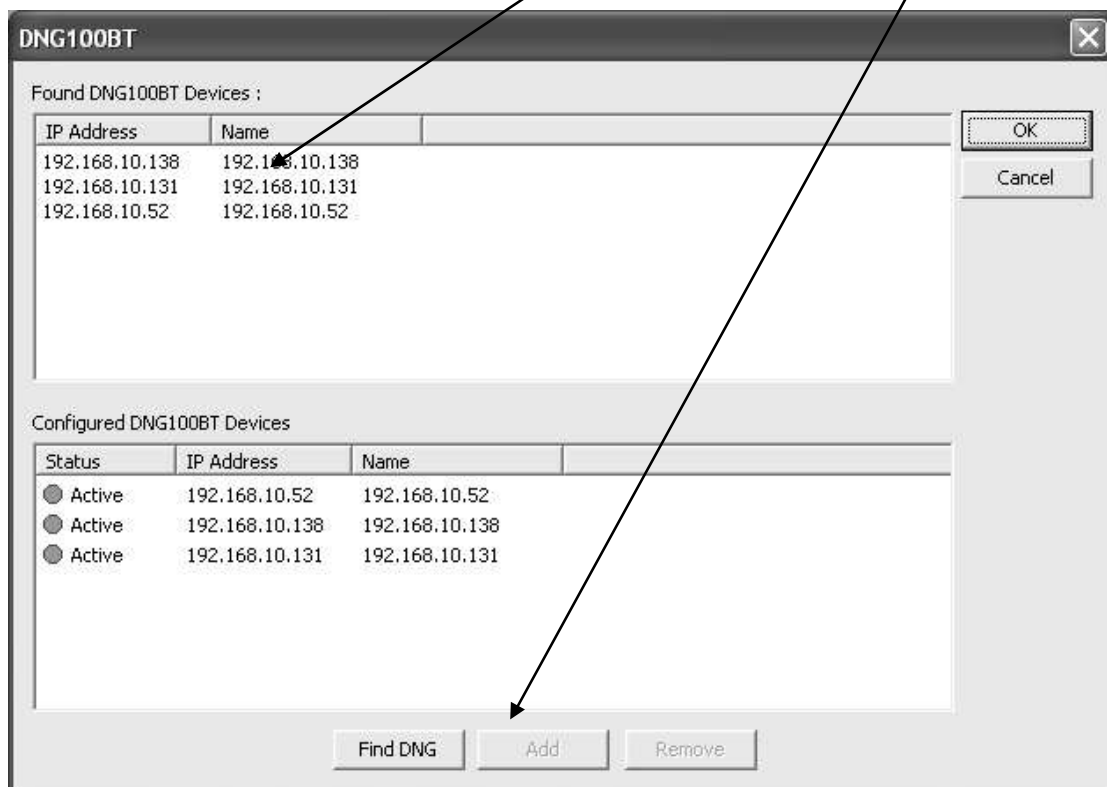

Fig 2.7

- Re-start Server.

- Startup MapView.

Note that the DLight III HTML log shall contain a record of any failed connections: **C:\Program Files\Dynalite\DLight III 3.3\DLightIII Server Log.html**  
E.g.

```

Event Log Opened at 7/2/2008, 16:36:06.531
7/2/2008, 16:36:06, Starting DLightIIIServer Version 3.3 Build 10
Command line: "C:\Program Files\Dynalite\DLight III 3.3\DLightIIIServer.exe" -console
Platform type: Microsoft Windows XP Professional Service Pack 2 (Build 2600)
7/2/2008, 16:36:28, Failed to open socket(IP address : 192.168.10.138, box number: 69)
7/2/2008, 16:36:38, Plugin {C2AC9D92-1DCD-44DD-AB30-AB04F5C4E8EB} registered as TrendPlugin
7/2/2008, 16:36:38, DLightIIIServer COM Object Created Successfully
7/2/2008, 16:36:43, Shutting Down DLightIII Server Version 3.3 Build 10
Closing Event Log at 7/2/2008, 16:36:43.421

```

You should be also able to add DNG100BT devices to MapView:

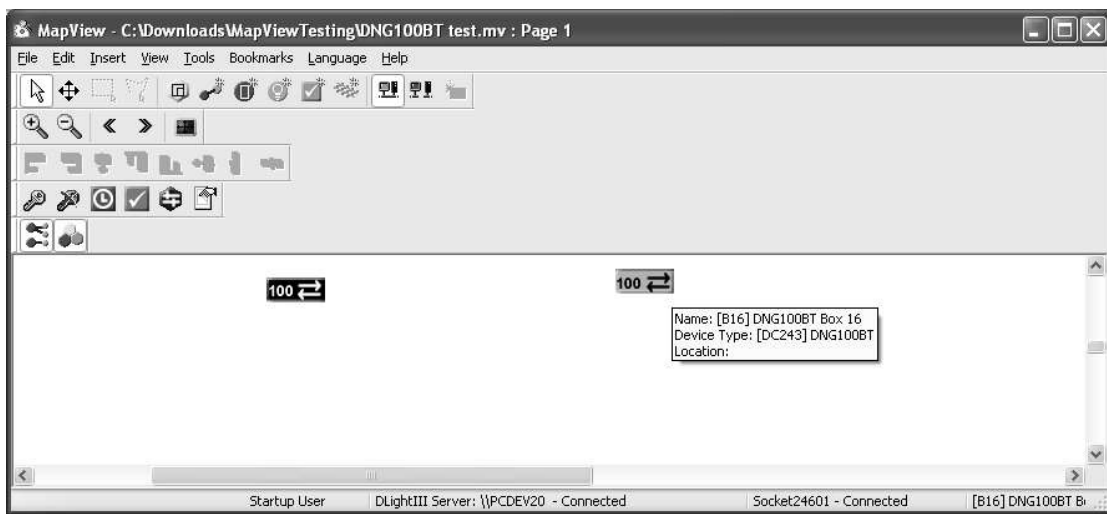

Fig 2.8

Also note that you will need to re-start the DLIII server if you add any additional entries to the **DNGManualConf.txt** file.

## Miscellaneous

Example 'Ethernet Data' config for DNG100BT box 18

NetVal for DyNet 2 Bridge Box 1

XPort (version 1.16 or older)  
 XPort (version 1.17 or newer)

Static IP Address  
Local IP Address (decimal)  
0.0.0.0 Assigned IP Address (decimal)  
0.0.0.0 Subnet Mask (decimal)  
0.0.0.0 Gateway (decimal)  
00:00:00:00:00:00 MAC Address (hex)

Telnet Config (port 9999) Password Enable  
Telnet Password (4 characters)

Passive TCP  
Local Port Number (decimal)  
0

UDP  
UDP Port Number (decimal)

HTML (Port 80)

Telnet (Port 23)

Active TCP  
Remote IP Address (decimal)  
0.0.0.0  
Remote Port Number (decimal)  
0

Dump

Fig 2.9