

Adaptive Power Module

The Adaptive Power Module family is a group of modular products for the control of lighting loads. This product is compatible with Lutron HomeWorks QS and myRoom systems only. This document describes the following product:

- LQSE-4A1-D-4 zone power module for phase control dimming.

Features

- Leading-edge or trailing-edge dimming for incandescent/halogen, electronic/magnetic low-voltage, and neon/cold cathode light sources.
- Controls dimmable CFL/LED loads. Refer to www.lutron.com/LEDtool for compatibility with dimmable CFL/LED light sources.
- RTISS Equipped technology compensates for incoming line-voltage variations (up to ± 2% change in frequency/second) such as changes in RMS voltage, frequency shifts, harmonics and line noise.
- Integral protection for temporary over-current and over-voltage conditions.
- SSL7 compliant for compatibility with Solid State Lighting.
- Includes QS link for seamless connection to a HomeWorks QS or myRoom system.
- LEDs on module provide diagnostic information.
- Buttons on module provide load override control.
- Manual Override Contact Closure Input (CCI).
- Power failure memory.

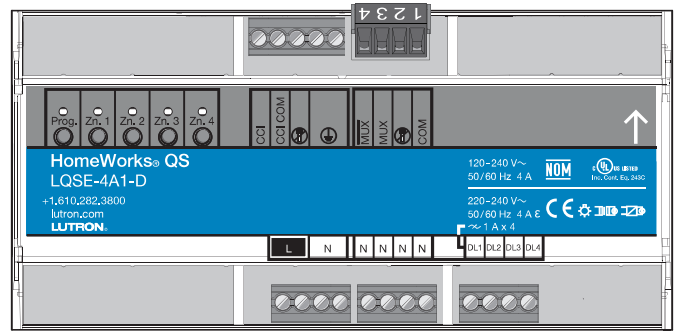

LQSE-4A1-D (shown)

System Example

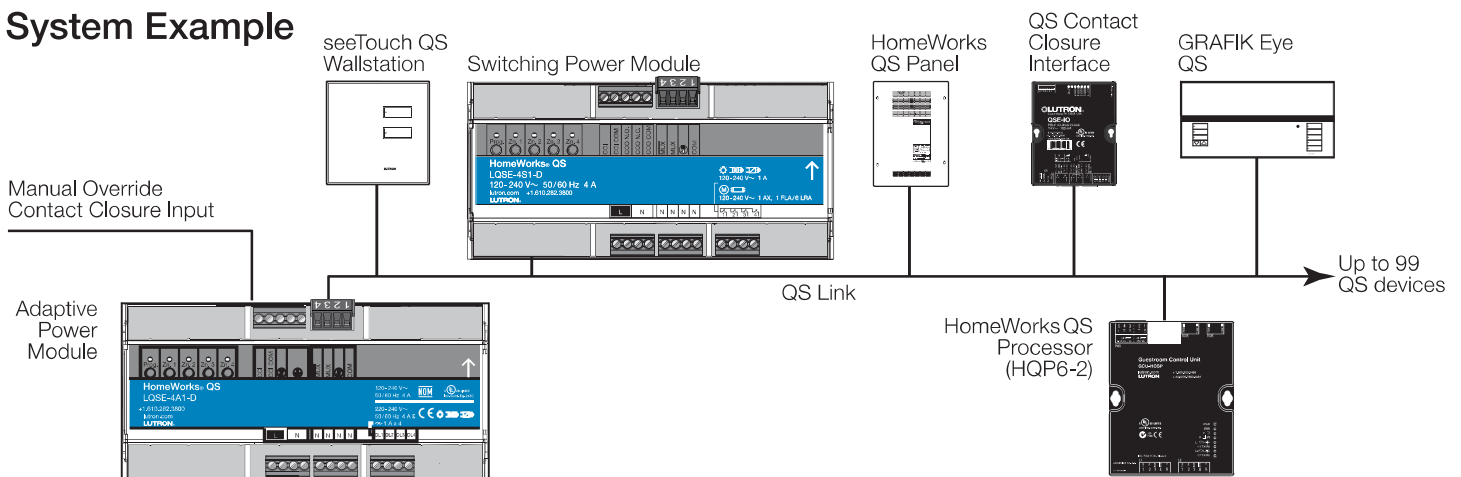

Job Name:	Model Numbers:	
<input type="text"/>	<input type="text"/>	<input type="text"/>
Job Number:	<input type="text"/>	<input type="text"/>

Specifications

Regulatory Approvals

- 120–240 V~ 50/60 Hz
 - UL® Listed
 - cUL® Listed
 - NOM Certified
 - RoHS compliant
- 220–240 V~ 50/60 Hz
 - IEC/EN 60669
 - RoHS compliant
- Lutron Quality Systems registered to ISO 9001.2008

Power

- 120–240 V~ 50/60 Hz (cULus and NOM)
- 220–240 V~ 50/60 Hz (IEC/EN 60669)
- Single input feed
- 4 A maximum total input current.
- Lightning strike protection meets ANSI/IEEE standard C62.41 and IEC 61000-4-5. Can withstand voltage surges of up to 6 000 V~ and current surges of up to 3 000 A.
- ESD protected above agency requirements per IEC 60669-2-1.
- For ungrounded delta feed applications, contact Lutron.

Environment

- For thermal specifications, see **Output Zone Rating and Mounting** section
- Relative humidity: less than 90% non-condensing
- For indoor use only

Terminals

- Mains wiring: 1.0 mm² to 2.5 mm² (18 AWG to 12 AWG) (single wire, solid or stranded)
- CCI wiring: 0.5 mm² to 2.5 mm² (22 AWG to 12 AWG) (single wire, solid or stranded)
- Zone wiring: 1.0 mm² to 2.5 mm² (18 AWG to 12 AWG) (single wire, solid or stranded)
- QS Link: 0.5 mm² to 2.5 mm² (22 AWG to 12 AWG) (single wire, solid or stranded)

Manual Mode Operation

- By default, each zone is set to Auto Detect non-dim load type. See **QS Dimming and Switching Power Module Installation Guide** at www.lutron.com for details on programming the load type.
- Zone buttons on the unit can be used to:
 - Turn loads on and off.
 - Dim loads up and down when configured to a dimmed load type.

Manual Override Contact Closure Input (CCI)

- When the CCI is open, the Adaptive Power Module will enter Manual Override Mode, which will turn on all loads to their manual override level and disable control of local zones and QS devices.
- When the CCI is closed or jumpered (factory default), Adaptive Power Module zones will return to the settings or levels they were at prior to entering Manual Override Mode.

Programming and Compatibility Requirements

- LQSE-4A1-D can be used with HomeWorks QS or myRoom systems.
- Setup and programming of the Adaptive Power Module is done through the HomeWorks QS or myRoom programming software.
- HomeWorks QS software version 9.0 or higher or any myRoom software version is required.

QS Link Limits

- A QS link in a HomeWorks QS or myRoom system can have up to 512 zones (outputs) and 100 devices (required HomeWorks QS or myRoom processor counts as 1 device on the QS link).
- Each Adaptive Power Module counts as one device toward the 100 device limit, and up to 4 zones toward the 512 zone limit.

Job Name: <input style="width: 90%;" type="text"/>	Model Numbers: <input style="width: 60%;" type="text"/> <input style="width: 30%;" type="text"/>	
Job Number: <input style="width: 150px;" type="text"/>	<input style="width: 300px;" type="text"/>	<input style="width: 300px;" type="text"/>

Specifications (continued)

Output Zone Ratings

- **No Derating** is required if all the conditions below are met:
 - Calibration point maximum is 70 °C (158 °F).
 - Room ambient temperature is between 0 °C and 30 °C (32 °F and 86 °F).
 - Panel ambient temperature, within 20 mm (0.80 in) of unit, is between 0 °C and 50 °C (32 °F and 122 °F).
- **25 W (@120 V~)/50 W (@240 V~): Derating** on all zones is required for a single module in a non-ventilated enclosure if the room ambient temperature is between 30 °C and 40 °C (86 °F and 104 °F).
- **50 W (@120 V~)/100 W (@240 V~): Derating** on all zones is required in a multiple row non-ventilated enclosure if the temperature is between 30 °C and 40 °C (86 °F and 104 °F).
- Each zone has a 5 W (incandescent) minimum load requirement. For LED compatibility details, see www.lutron.com/LEDTool and Application note #557 (Lutron PN 048557).
- Does not support non-dimmable loads
- Automatically selects leading-edge or trailing-edge dimming when configured to "Auto-detect". It can also be configured for a specific load type.
- One load type per zone.
- This module is designed to control loads with ratings as noted in the table below. Outputs cannot be used to control general purpose receptacles.
- Special considerations:
 - When controlling lamps, Lutron recommends using permanently installed fixtures.
 - If controlling plug-in lamps, installation must ensure a method of preventing non-rated loads being plugged into the unit. An example is a dedicated receptacle with an alternate plug load such as a Duplex Dimming Receptacle (NTR-15-DFDU-) and Dimming Lamp Plug (RP-FDU-10-) or installing an In-Line Fuse (Application Note #566 (Lutron PN 048566): <http://www.lutron.com/TechnicalDocumentLibrary/048566.pdf>)
 - Controlling loads outside the parameters listed in the table below may damage the device and void the warranty.
- Output must be directly connected to the load, outputs are not compatible with load side switching (i.e., breakers, switches, etc.).
- Run a separate neutral for each load circuit. A common neutral connection is not recommended.
- Maximum wire length between Adaptive Power Module and the load must be less than 30.5 m (100 ft).
- Unit may be powered by Ground Fault Interrupter (GFI) or Residual Current Circuit Breaker with Overload (RCBO) protected circuit if required. Load circuit wiring (from breaker to unit to load) must be run in its own non-metallic conduit, or nuisance tripping may occur.
- For applications requiring 0–10 V_{DC} control, use a Ten Volt Interface (GRX-TVI) or a 0–10 V Adaptive Power Module (LQSE-4T10-D).
- For applications requiring higher wattage ratings, use NGRX-PB, NGRX-ELVI or LQSE-4A-D for 230 V~ or PPHPM-PA for 120 V~.

⚠ WARNING – Entrapment Hazard – May result in serious injury or death. These controls should only be used to control equipment which is visible from every control location.

⚠ WARNING – Fire Hazard – May result in serious injury or death. Only use these controls to operate approved load and equipment types.

IMPORTANT NOTE: Examples of such equipment which must not be operated by these controls include (but are not limited to) motorized gates, garage doors, industrial doors, microwave ovens, heating pads, fireplaces, space heaters, etc. It is the installer's responsibility to ensure that the equipment being controlled is visible from every control location and that only suitable equipment is connected to these controls. Failure to do so could result in serious injury or death.

Each zone is rated for the following wattage and load types^A:

Load Type	Zones 1 – 4			
	120 V~	220 V~	230 V~	240 V~
Incandescent/Halogen	120 W	220 W	230 W	240 W
Electronic Low-Voltage	120 W	220 W	230 W	240 W
Magnetic Low-Voltage ^B	120 VA (90 W ^C)	220 VA (165 W ^C)	230 VA (172 W ^C)	240 VA (180 W ^C)
Neon/Cold Cathode ^B	120 VA (90 W ^C)	220 VA (165 W ^C)	230 VA (172 W ^C)	240 VA (180 W ^C)
Hi-lume A-Series LTE	120 VA 1-6 drivers	N/A	N/A	N/A

^A Refer to www.lutron.com/LEDTool and Application Note #557 (Lutron PN 048557) for compatibility with dimmable CFL/LED light sources.

^B Only use iron core transformers intended for use with an electronic switch or dimmer per Clause 8.3 of IEC/EN 60669-2-1.

^C Actual lamp wattage.

LUTRON SPECIFICATION SUBMITTAL

Job Name: <input style="width: 90%; height: 20px;" type="text"/>	Model Numbers: <input style="width: 95%; height: 20px;" type="text"/>	
Job Number: <input style="width: 80%; height: 20px;" type="text"/>	<input style="width: 95%; height: 20px;" type="text"/>	<input style="width: 95%; height: 20px;" type="text"/>

Mechanical Dimensions

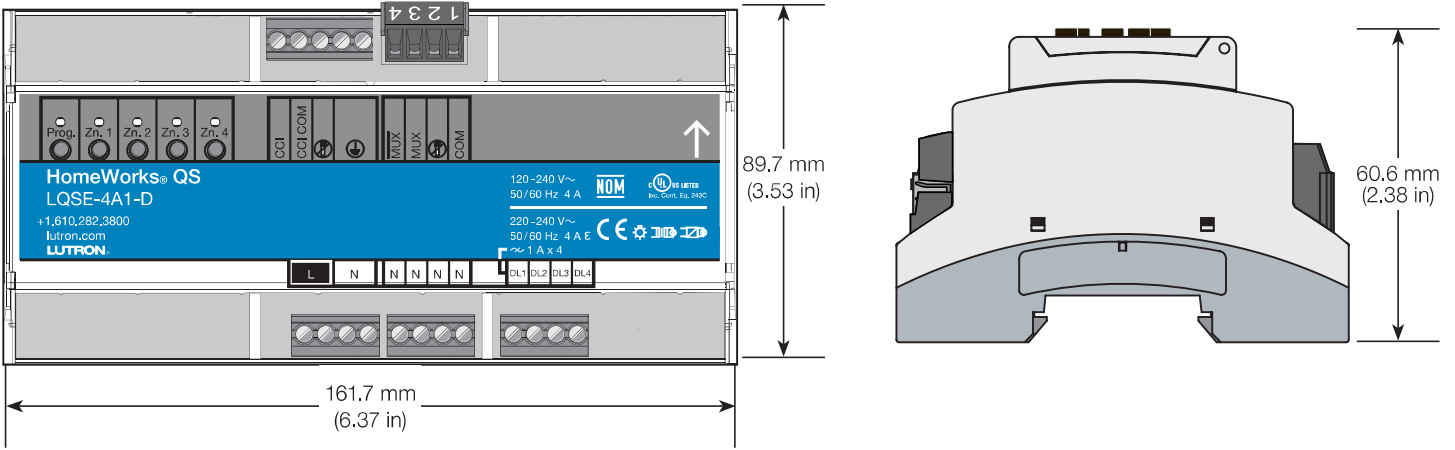

Mounting

- Mount in IP20 (minimum) rated consumer panel or breaker panel with integrated DIN rail.
- For United States and Canada, use NEMA Type 1 minimum rated enclosure.
- Unit is 9 DIN modules (161.7 mm [6.37 in]) wide.
- Mount in an accessible and serviceable location.
- Unit may be mounted by pressing the unit onto the DIN rail with the clips locked. To remove the unit from the DIN rail, unlock the clips using a screwdriver.
- Mount with arrows facing up to ensure adequate cooling.
- See Lutron P/N 048466 at www.lutron.com for more information on mounting and installation in panels with integrated DIN rail.
- Mount the Power Module where audible noise is acceptable (internal relay clicks).
- Unit generates heat, maximum 35 BTUs/Hour.
- Mount unit such that all the conditions below are met:
 - Room ambient temperature is between 0 °C and 40 °C (32 °F and 104 °F). Zone derating applies for unventilated enclosures when ambient temperature is >30 °C (86 °F).
 - Temperature inside mounting panel, within 20 mm (0.80 in) of unit, is between 0 °C and 50 °C (32 °F and 122 °F).
 - Calibration point maximum: 70 °C (158 °F).

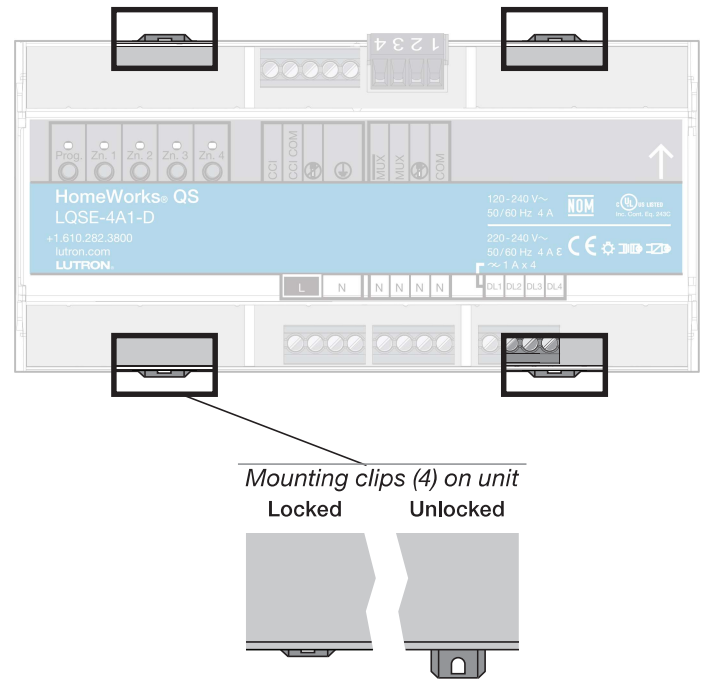

Job Name: <input type="text"/>	Model Numbers: <input type="text"/>	
Job Number: <input type="text"/>	<input type="text"/>	<input type="text"/>

Wiring: Mains and Output Zones

Wiring from Distribution to Adaptive Power Module

- Turn off all circuit breakers or isolators feeding the Adaptive Power Module at the distribution panel.
- Run line/hot and neutral wires from a 120–240 V~ 50/60 Hz feed to the Adaptive Power Module unit.
- Run a separate neutral for each load circuit. A common neutral connection is not recommended.

Mains Wiring and IEC PELV/NEC® Class 2 Separation

- Follow appropriate local and national codes to avoid violating required separation guidelines.

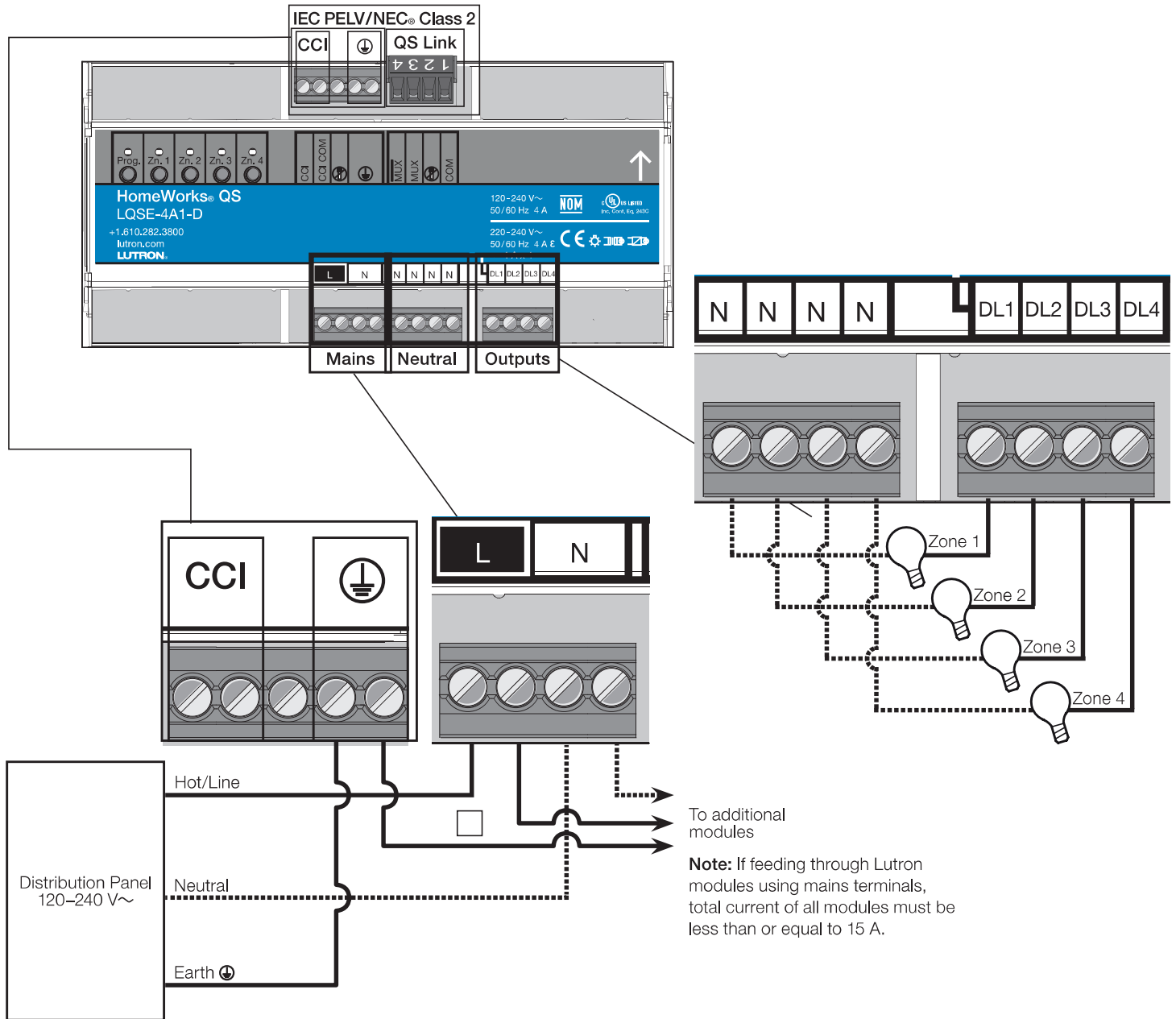

Job Name:	Model Numbers:	
<input type="text"/>	<input type="text"/>	<input type="text"/>
Job Number:	<input type="text"/>	<input type="text"/>

Wiring: Manual Override Contact Closure Input

IEC PELV/NEC® Class 2 Manual Override Contact Closure Input

- Contact Closure Input (CCI) wiring is IEC PELV/NEC® Class 2. Follow all applicable national and local codes for proper circuit separation and protection.
- Turn off all breakers or isolators feeding the Adaptive Power Module at distribution panel before servicing unit.
- CCI is local control only and cannot control other units over the QS link. CCI on multiple units may be connected to an emergency or manual override device in parallel if event is intended to affect multiple devices.
- When in Manual Override Mode:
 - All zone outputs will be at their programmed light level (default is 100%).
 - Controls will not affect units in Manual Override Mode.
 - Controls connected to a unit in Manual Override Mode will continue to affect units on the link that are not in Manual Override Mode.
- Manual override contact closure input is normally closed (N.C.). The Adaptive Power Module is shipped with a jumper pre-installed.

Note: The Adaptive Power Module will default to Manual Override Mode if the CCI is left open. If no manual override contact input is required, please leave the wire jumper in the CCI terminals.

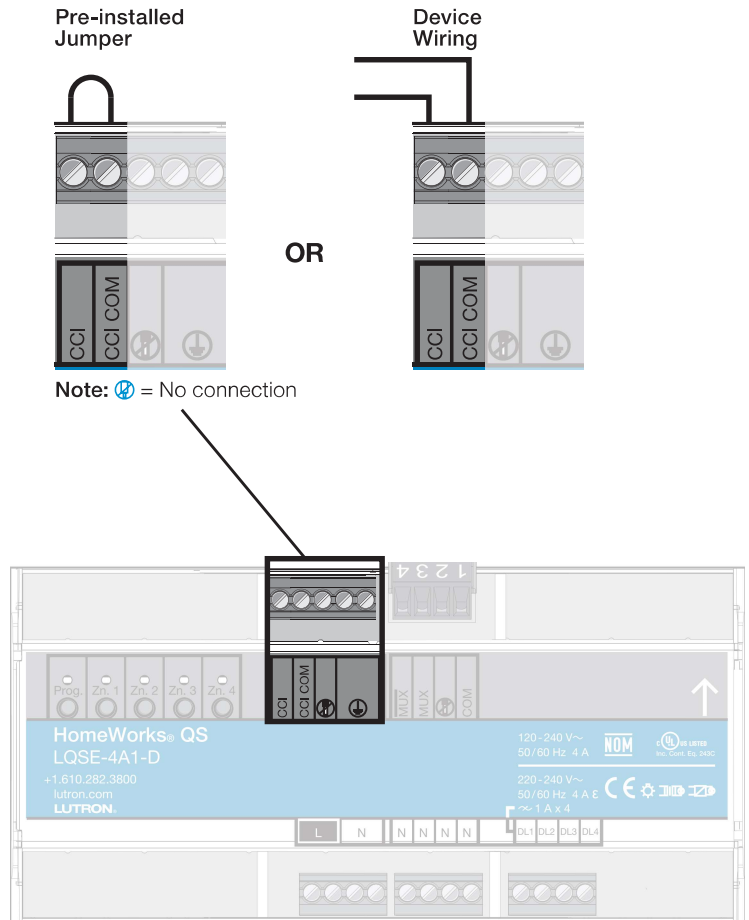

Job Name: <input style="width: 90%; height: 20px;" type="text"/>	Model Numbers: <input style="width: 95%; height: 20px;" type="text"/>
Job Number: <input style="width: 80%; height: 20px;" type="text"/>	<input style="width: 95%; height: 20px;" type="text"/>

Wiring: QS Link

QS Link IEC PELV/NEC® Class 2 Wiring

- Link communicates using IEC PELV/NEC® Class 2 wiring.
- Turn off all breakers or isolators feeding the Adaptive Power Module at distribution panel before servicing unit.
- Follow all applicable national and local codes for proper circuit separation and protection.
- Wiring may be daisy chained or t-tapped.
- Total length of QS link wiring must not exceed 610 m (2 000 ft).
- Wire Gauge:
 - Control (terminals 1 and 2): 1 pair 1.0 mm² (18 AWG).
 - Data (terminals 3 and 4): 1 pair 0.5 mm² to 1.0 mm², (22 AWG to 18 AWG) twisted and shielded.
 - Can use Lutron cable GRX-CBL-346S-500.
- See “HomeWorks QS Wiring Guidelines” application note on www.lutron.com

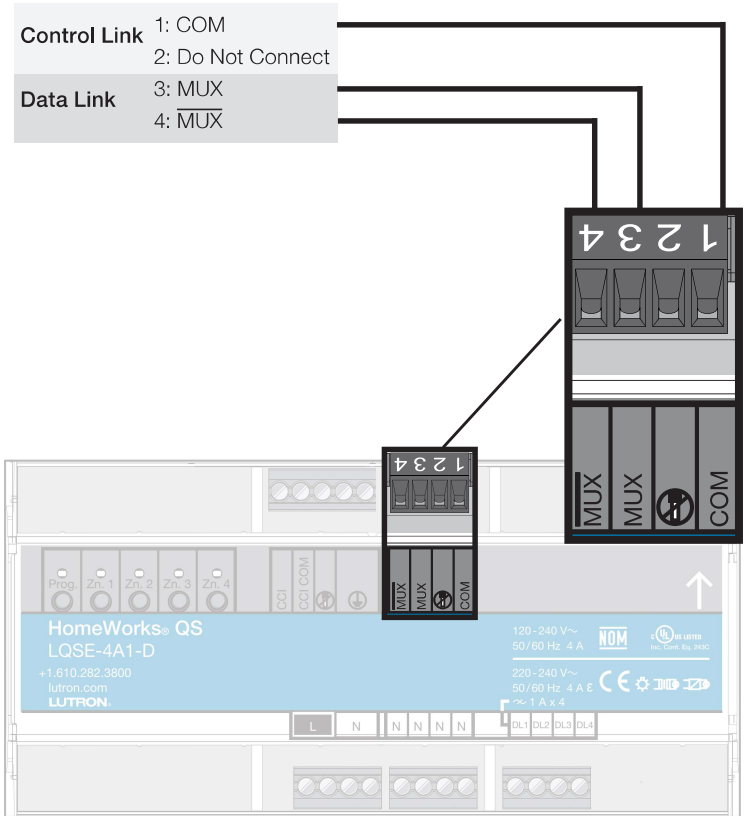

The Lutron logo, Lutron, HomeWorks, myRoom, RTISS Equipped, seeTouch, GRAFIK Eye, and Hi-lume are trademarks or registered trademarks of Lutron Electronics Co., Inc. in the US and/or other countries. All other product names, logos, and brands are property of their respective owners.

Job Name: <input type="text"/>	Model Numbers: <input type="text"/>	
Job Number: <input type="text"/>	<input type="text"/>	<input type="text"/>